

# FORD **B-MAX** Owner's Manual



The information contained in this publication was correct at the time of going to print. In the interest of continuous development, we reserve the right to change specifications, design or equipment at any time without notice or obligation. No part of this publication may be reproduced, transmitted, stored in a retrieval system or translated into any language in any form by any means without our written permission. Errors and omissions excepted.

© Ford Motor Company 2012

All rights reserved.

Part Number: CG3573en 07/2012 20120727135841

# Table of Contents

---

## Introduction

About This Manual.....	5
Symbols Glossary.....	5
Replacement Parts Recommendation.....	7
Mobile Communications Equipment.....	7

## At a Glance

At a Glance.....	8
------------------	---

## Child Safety

Installing Child Seats.....	14
Child Seat Positioning.....	16
Child Safety Locks.....	19

## Seat Belts

Fastening the Seat Belts.....	20
Seat Belt Minder.....	21

## Supplementary Restraints System

Principle of Operation.....	22
Driver Airbag.....	22
Passenger Airbag.....	22
Side Airbags.....	23
Knee Airbag.....	24
Side Curtain Airbags.....	24

## Keys and Remote Controls

General Information on Radio Frequencies.....	25
Remote Control.....	25
Replacing a Lost Key or Remote Control.....	28

## Locks

Locking and Unlocking.....	29
Sliding Door.....	30
Manual Liftgate.....	31

Keyless Entry.....	32
--------------------	----

## Security

Passive Anti-Theft System.....	35
Anti-Theft Alarm.....	35

## Steering Wheel

Adjusting the Steering Wheel.....	38
Audio Control.....	38
Voice Control.....	39
Cruise Control.....	39

## Wipers and Washers

Windscreen Wipers.....	40
Autowipers.....	40
Windscreen Washers.....	41
Rear Window Wiper and Washers.....	41

## Lighting

Lighting Control.....	43
Autolamps.....	43
Instrument Lighting Dimmer.....	44
Headlamp Exit Delay.....	44
Daytime Running Lamps.....	45
Front Fog Lamps.....	45
Rear Fog Lamps.....	45
Headlamp Levelling.....	46
Direction Indicators.....	47
Interior Lamps.....	47

## Windows and Mirrors

Power Windows.....	48
Exterior Mirrors.....	49
Interior Mirror.....	50
Childminder Mirror.....	50
Global Opening and Closing.....	51

## Instrument Cluster

Gauges.....	53
-------------	----

# Table of Contents

---

Warning Lamps and Indicators.....	53
Audible Warnings and Indicators.....	56

## Information Displays

General Information.....	58
Clock.....	61
Trip Computer.....	61
Personalised Settings.....	62
Information Messages.....	62

## Climate Control

Principle of Operation.....	68
Air Vents.....	68
Manual Climate Control.....	69
Automatic Climate Control.....	70
Hints on Controlling the Interior Climate.....	72
Heated Windows and Mirrors.....	75

## Seats

Sitting in the Correct Position.....	76
Head Restraints.....	76
Manual Seats.....	78
Rear Seats.....	79
Heated Seats.....	80
Front Seat Armrest.....	80

## Auxiliary Power Points

Auxiliary Power Points.....	81
Cigar Lighter.....	81

## Storage Compartments

Cup Holders.....	82
Glasses Holder.....	82

## Starting and Stopping the Engine

General Information.....	83
Ignition Switch.....	83
Keyless Starting.....	83

Steering Wheel Lock.....	85
Starting a Petrol Engine.....	85
Starting a Diesel Engine.....	86
Diesel Particulate Filter.....	87
Switching Off the Engine.....	88

## Unique Driving Characteristics

Start-Stop.....	89
-----------------	----

## Fuel and Refuelling

Safety Precautions.....	91
Fuel Quality - Petrol.....	92
Fuel Quality - Diesel.....	92
Running Out of Fuel.....	92
Catalytic Converter.....	93
Refuelling.....	93
Fuel Consumption.....	95
Technical Specifications.....	96

## Transmission

Manual Transmission.....	97
Automatic Transmission.....	97
Hill Start Assist.....	99

## Brakes

General Information.....	101
Hints on Driving With Anti-Lock Brakes.....	101
Parking Brake.....	101

## Stability Control

Principle of Operation.....	103
Using Stability Control.....	103

## Parking Aids

Principle of Operation.....	104
Parking Aid.....	104
Rear View Camera.....	106

# Table of Contents

---

## Cruise Control

Principle of Operation.....	109
Using Cruise Control.....	109

## Driving Aids

Active City Stop.....	111
-----------------------	-----

## Load Carrying

General Information.....	113
Luggage Anchor Points.....	113
Rear Under Floor Storage.....	113
Cargo Nets.....	114
Luggage Covers.....	114
Dog Guard.....	114

## Towing

Towing a Trailer.....	116
Tow Ball.....	116
Towing Points.....	119
Towing the Vehicle on Four Wheels.....	119

## Driving Hints

Running-In.....	121
Cold Weather Precautions.....	121
Driving Through Water.....	121
Floor Mats.....	121

## Roadside Emergencies

Hazard Warning Flashers.....	122
First Aid Kit.....	122
Warning Triangle.....	122
Jump-Starting the Vehicle.....	122

## Fuses

Fuse Box Locations.....	124
Fuse Specification Chart.....	125
Changing a Fuse.....	133

## Maintenance

General Information.....	134
Opening and Closing the Bonnet.....	134
Under Bonnet Overview - 1.0L EcoBoost (74kW/100PS)/1.0L EcoBoost (90kW/120PS).....	136
Under Bonnet Overview - 1.4L Duratec-16V (66kW/90PS)/1.6L Duratec-16V Ti-VCT (77kW/105PS) - Sigma.....	137
Under Bonnet Overview - 1.5L Duratorq-TDCi (55kW/75PS)/1.6L Duratorq-TDCi (70kW/95PS) (T3).....	138
Engine Oil Dipstick - 1.0L EcoBoost (74kW/100PS)/1.0L EcoBoost (90kW/120PS).....	139
Engine Oil Dipstick - 1.4L Duratec-16V (66kW/90PS)/1.6L Duratec-16V Ti-VCT (77kW/105PS) - Sigma.....	139
Engine Oil Dipstick - 1.5L Duratorq-TDCi (55kW/75PS)/1.6L Duratorq-TDCi (70kW/95PS) (T3).....	139
Engine Oil Check.....	139
Engine Coolant Check.....	140
Brake and Clutch Fluid Check.....	141
Washer Fluid Check.....	141
Changing the 12V Battery.....	141
Checking the Wiper Blades.....	141
Changing the Wiper Blades.....	141
Removing a Headlamp.....	142
Changing a Bulb.....	143
Bulb Specification Chart.....	149
Technical Specifications.....	150

## Vehicle Care

Cleaning the Exterior.....	153
Cleaning the Interior.....	153
Repairing Minor Paint Damage.....	154
Cleaning the Alloy Wheels.....	154

## Wheels and Tyres

General Information.....	155
--------------------------	-----

# Table of Contents

---

Temporary Mobility Kit.....	155
Tyre Care.....	158
Using Winter Tyres.....	159
Using Snow Chains.....	159
Tyre Pressure Monitoring System.....	159
Changing a Road Wheel.....	160
Technical Specifications.....	164

## Appendices

Electromagnetic compatibility.....	225
End User Licence Agreement.....	226

## Capacities and Specifications

Vehicle Identification Plate.....	167
Vehicle Identification Number.....	168
Technical Specifications.....	168

## Audio System

General Information.....	171
Audio unit - Vehicles With: AM/FM/CD.....	172
Audio unit - Vehicles With: AM/FM/CD/Bluetooth.....	177
Audio unit - Vehicles With: Sony AM/FM/CD.....	182
Audio System Security.....	187
Compact Disc Player - Vehicles With: AM/FM/CD.....	187
Compact Disc Player - Vehicles With: AM/FM/CD/Bluetooth/Sony AM/FM/CD.....	190
Auxiliary Input Socket.....	194
Audio Troubleshooting.....	195

## SYNC

General Information.....	196
Using Voice Recognition.....	198
Using SYNC® With Your Phone.....	200
SYNC® Applications and Services.....	211
Using SYNC® With Your Media Player.....	213
SYNC® Troubleshooting.....	218

# Introduction

## ABOUT THIS MANUAL

Thank you for choosing Ford. We recommend that you take some time to get to know your vehicle by reading this manual. The more that you know about it, the greater the safety and pleasure you will get from driving it.

### WARNING



Always drive with due care and attention when using and operating the controls and features on your vehicle.

**Note:** This manual describes product features and options available throughout the range, sometimes even before they are generally available. It may describe options not fitted to your vehicle.

**Note:** Some of the illustrations in this manual may be used for different models, so may appear different to your vehicle. However, the essential information in the illustrations is always correct.

**Note:** Always use and operate your vehicle in line with all applicable laws and regulations.

**Note:** Pass on this manual when selling your vehicle. It is an integral part of the vehicle.

## Protecting the Environment

You must play your part in protecting the environment. Correct vehicle usage and the authorised disposal of waste, cleaning and lubrication materials are significant steps toward this aim.

## SYMBOLS GLOSSARY

These are some of the symbols you may see on your vehicle.



Safety alert



See Owner's Manual



Anti-lock braking system



Avoid smoking, flames or sparks



Battery



Battery acid



Brake fluid - non petroleum based



Brake system



Cabin air filter



Check fuel cap



Child safety door lock or unlock



Child seat lower anchor



Child seat tether anchor



Cruise control



Do not open when hot

# Introduction

---



Engine air filter



Engine coolant



Engine coolant temperature



Engine oil



Explosive gas



Fan warning



Fasten seat belt



Front airbag



Front fog lamps



Fuel pump reset



Fuse compartment



Hazard warning flashers



Heated rear window



Heated windscreen



Interior luggage compartment release



Jack



Lighting control



Low tyre pressure warning



Maintain correct fluid level



Panic alarm



Parking aid



Parking brake



Power steering fluid



Power windows front/rear



Power window lockout



Service engine soon



Side airbag



Stability control



Windscreen wash and wipe



# Introduction

---

## REPLACEMENT PARTS RECOMMENDATION

Your vehicle has been built to the highest standards using quality parts. We recommend that you demand the use of genuine Ford and Motorcraft parts whenever your vehicle requires scheduled maintenance or repair. You can clearly identify genuine Ford and Motorcraft parts by looking for the Ford, FoMoCo or Motorcraft branding on the parts or their packaging.

### Scheduled Maintenance and Mechanical Repairs

One of the best ways for you to make sure that your vehicle provides years of service is to have it maintained in line with our recommendations using parts that conform to the specifications detailed in this Owner's Manual. Genuine Ford and Motorcraft parts meet or exceed these specifications.

### Collision Repairs

We hope that you never experience a collision, but accidents do happen. Genuine Ford replacement collision parts meet our stringent requirements for fit, finish, structural integrity, corrosion protection and dent resistance. During vehicle development we validate these parts deliver the intended level of protection as a whole system. A great way to know for sure you are getting this level of protection is to use genuine Ford replacement collision parts.

## Warranty on Replacement Parts

Genuine Ford and Motorcraft replacement parts are the only replacement parts that benefit from a Ford Warranty. Damage caused to your vehicle as a result of the failure of non-Ford parts may not be covered by the Ford Warranty. For additional information, refer to the terms and conditions of the Ford Warranty.

## MOBILE COMMUNICATIONS EQUIPMENT

Using mobile communications equipment is becoming increasingly important in the conduct of business and personal affairs. However, you must not compromise your own or others' safety when using such equipment. Mobile communications can enhance personal safety and security when appropriately used, particularly in emergency situations. Safety must be paramount when using mobile communications equipment to avoid negating these benefits. Mobile communication equipment includes, but is not limited to, cellular phones, pagers, portable email devices, text messaging devices and portable two-way radios.

### WARNING



Driving while distracted can result in loss of vehicle control, accident and injury. We strongly recommend that you use extreme caution when using any device or feature that may take your focus off the road. Your primary responsibility is the safe operation of your vehicle. We recommend against the use of any handheld device while driving and that you comply with all applicable laws.

---

# At a Glance

## Front Exterior Overview

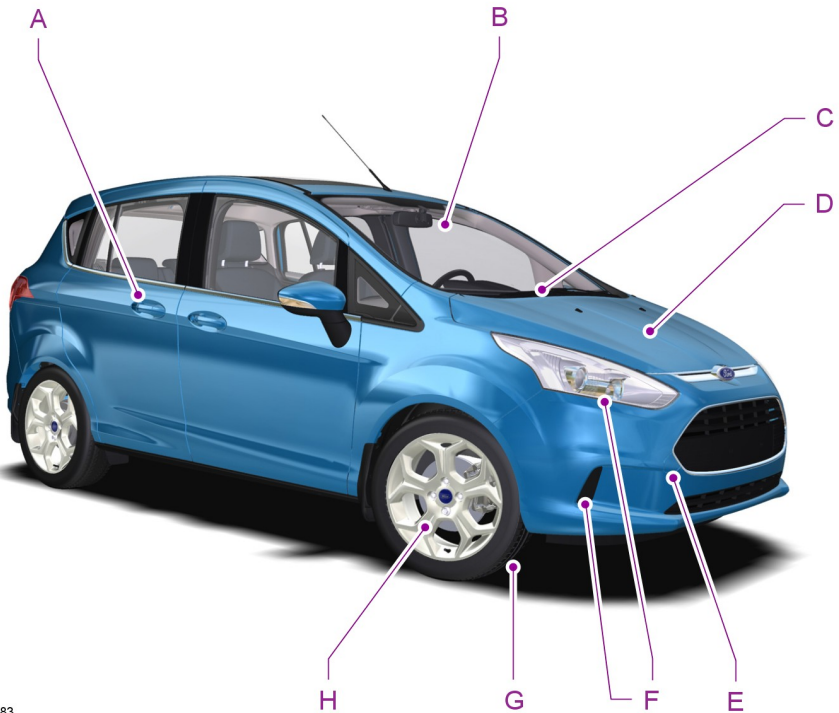

E141783

- A See **Locking and Unlocking** (page 29). See **Keyless Entry** (page 32).
- B See **Active City Stop** (page 111).
- C See **Changing the Wiper Blades** (page 141).
- D See **Maintenance** (page 134).
- E See **Towing Points** (page 119).
- F See **Changing a Bulb** (page 143).
- G Tyre pressures. See **Technical Specifications** (page 164).
- H See **Changing a Road Wheel** (page 160).

# At a Glance

## Vehicle Interior Overview

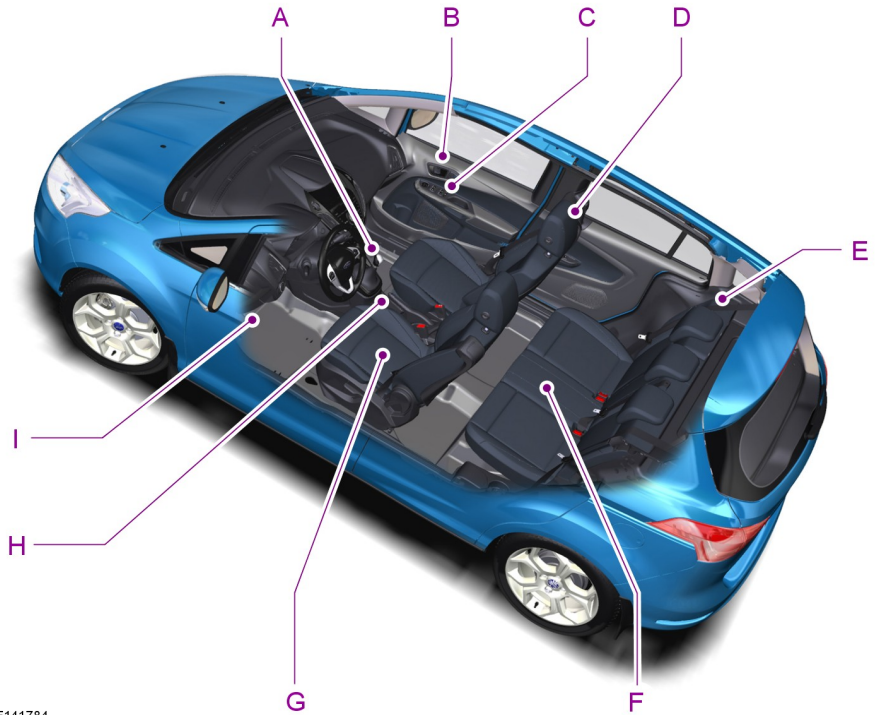

E141784

- A See **Transmission** (page 97).
- B See **Locking and Unlocking** (page 29).
- C See **Power Windows** (page 48). See **Exterior Mirrors** (page 49).
- D See **Head Restraints** (page 76).
- E See **Fastening the Seat Belts** (page 20).
- F See **Rear Seats** (page 79).
- G See **Manual Seats** (page 78).
- H See **Parking Brake** (page 101).
- I See **Opening and Closing the Bonnet** (page 134).

# At a Glance

## Instrument Panel Overview

### Left-Hand Drive

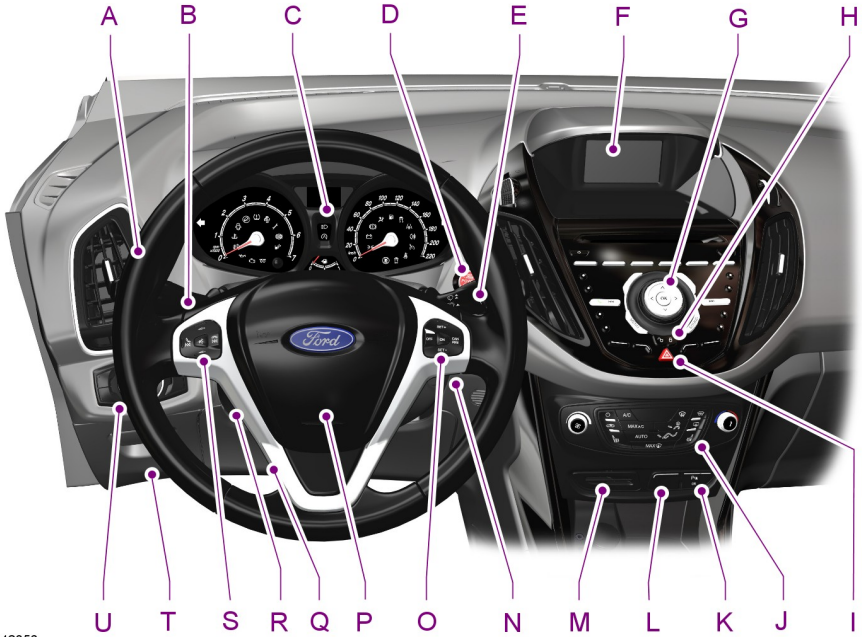

E142356

# At a Glance

## Right-Hand Drive

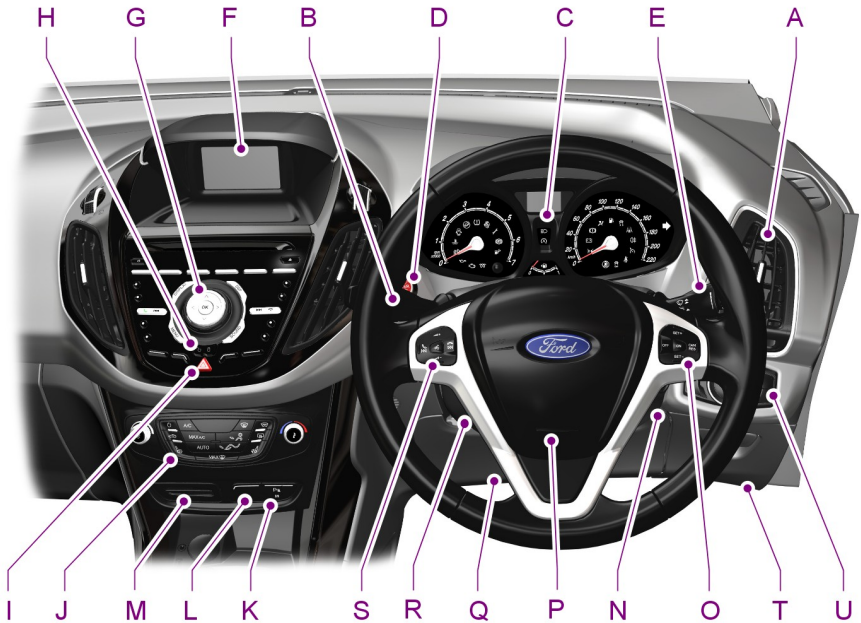

E142357

- A Air vents. See **Air Vents** (page 68).
- B Direction indicators. See **Direction Indicators** (page 47). Main beam. See **Lighting Control** (page 43).
- C Instrument cluster. See **Gauges** (page 53). See **Warning Lamps and Indicators** (page 53).
- D Start button. See **Starting and Stopping the Engine** (page 83).
- E Wiper lever. See **Wipers and Washers** (page 40).
- F Information and entertainment display. See **Information Displays** (page 58).
- G Audio unit. See **Audio System** (page 171).
- H Power door lock button. See **Locking and Unlocking** (page 29).
- I Hazard warning flasher switch. See **Hazard Warning Flashers** (page 122).
- J Climate controls. See **Climate Control** (page 68).

## At a Glance

---

- J Heated rear window switch. See **Climate Control** (page 68).
- J Heated windscreen switch. See **Climate Control** (page 68).
- K Parking aid switch. See **Parking Aids** (page 104).
- L Start-stop switch. See **Start-Stop** (page 89).
- M Card holder or airbag warning lamp. See **Passenger Airbag** (page 22).
- N Ignition switch. See **Ignition Switch** (page 83).
- O Cruise control switches. See **Using Cruise Control** (page 109).
- P Horn.
- Q Driver knee airbag. See **Knee Airbag** (page 24).
- R Steering wheel adjustment. See **Adjusting the Steering Wheel** (page 38).
- S Audio control. See **Audio System** (page 171). Voice control. See **Voice Control** (page 39).
- T Bonnet release lever. See **Opening and Closing the Bonnet** (page 134).
- U Lighting control. See **Lighting Control** (page 43). Front fog lamps. See **Front Fog Lamps** (page 45). Rear fog lamp. See **Rear Fog Lamps** (page 45). Instrument lighting dimmer. See **Instrument Lighting Dimmer** (page 44).

# At a Glance

## Rear Exterior Overview

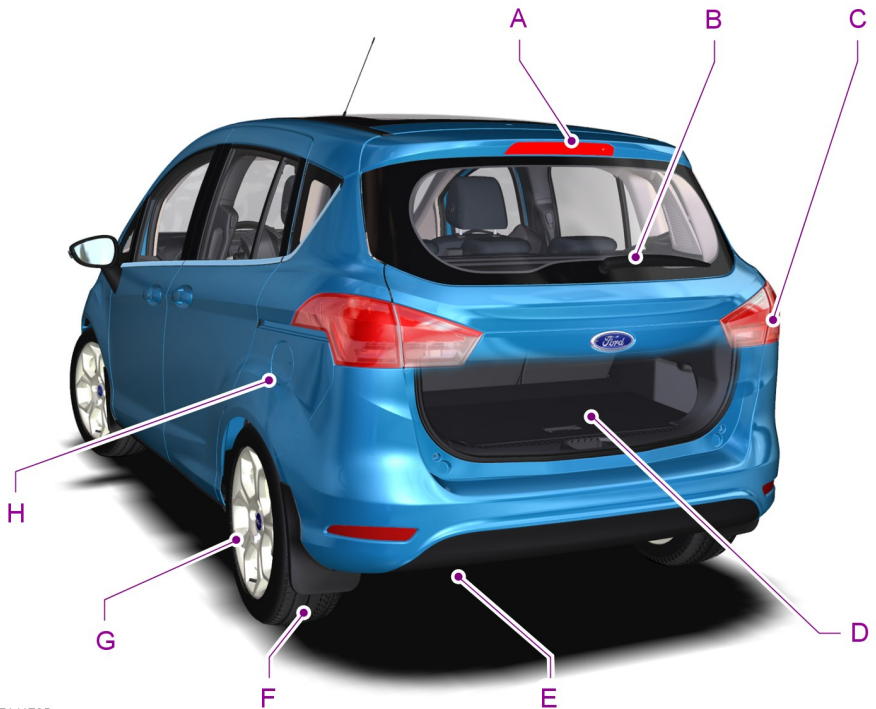

E141785

- A See **Changing a Bulb** (page 143).
- B See **Changing the Wiper Blades** (page 141).
- C See **Changing a Bulb** (page 143).
- D See **First Aid Kit** (page 122). See **Warning Triangle** (page 122). See **Temporary Mobility Kit** (page 155). Spare wheel, jack, and wheel brace. See **Changing a Road Wheel** (page 160). Towing eye. See **Towing Points** (page 119).
- E See **Towing Points** (page 119).
- F Tyre pressures. See **Technical Specifications** (page 164).
- G See **Changing a Road Wheel** (page 160).
- H See **Refuelling** (page 93).

# Child Safety

## INSTALLING CHILD SEATS









E133140



E68916

### WARNINGS

-  Use an approved child seat to secure children less than 59 inches (150 centimetres) tall in the rear seat.
-  Extreme Hazard! Do not use a rearward facing child seat on a seat protected by an air bag in front of it!
-  Read and follow the manufacturer's instructions when you are installing a child seat.
-  Do not modify child seats in any way.
-  Do not hold a child on your lap when your vehicle is moving.
-  Do not leave unattended children in your vehicle.

### WARNINGS

-  If your vehicle has been involved in a collision, have the child seats checked by an authorised dealer.

**Note:** *Mandatory use of child seats varies from country to country.*

Only child seats certified to ECE-R44.03 (or later) have been tested and approved for use in your vehicle. A choice of these are available from an authorised dealer.

## Child Seats for Different Mass Groups

Use the correct child seat as follows:

### Baby Safety Seat



E68918

Secure children that weigh less than 29 pounds (13 kilogrammes) in a rearward facing baby safety seat (Group 0+) on the rear seat.



# Child Safety

## Child Safety Seat



E68920

Secure children that weigh between 29 and 40 pounds (13 and 18 kilograms) in a child safety seat (Group 1) on the rear seat.

## Booster Seat (Group 2)







E70710

Secure children that weigh more than 33 pounds (15 kilograms) but are less than 59 inches (150 centimetres) tall in a booster seat or a booster cushion.

We recommend that you use a booster seat that combines a cushion with a backrest instead of a booster cushion only. The raised seating position will allow you to position the shoulder strap of the adult seat belt over the centre of your child's shoulder and the lap strap tightly across their hips.

## Booster Seats

### WARNINGS

-  Do not install a booster seat or a booster cushion with only the lap strap of the seat belt.
-  Do not install a booster seat or a booster cushion with a seat belt that is slack or twisted.
-  Do not put the seat belt under your child's arm or behind their back.
-  Do not use pillows, books or towels to boost your child's height.
-  Make sure that your children sit in an upright position.

**Note:** When using a child seat on a rear seat, make sure that the child seat rests tightly against your vehicle seat. It may be necessary to lift or remove the head restraint. See **Head Restraints** (page 76).

## Booster Cushion (Group 3)



E68924

# Child Safety

## ISOFIX Anchor Points

### WARNING



Use an anti-rotation device when using the ISOFIX system. We recommend the use of a top tether or support leg.

**Note:** When you are purchasing an ISOFIX seat, make sure that you know the correct mass group and ISOFIX size class for the intended seating locations. See **Child Seat Positioning** (page 16).

Your vehicle has ISOFIX anchor points that accommodate universally approved ISOFIX child seats.

The ISOFIX system comprises two rigid attachment arms on the child seat that attach to anchor points on the outboard rear seats, where the cushion and backrest meet. Tether anchor points are located behind the outboard rear seats for child seats with a top tether.

## Top Tether Anchor Points



E142244

## Attaching a Child Seat With Top Tethers

### WARNINGS



Do not attach a tether strap to anything other than the correct tether anchor point.



Make sure that the top tether strap is not slack or twisted and is properly located on the anchor point.

**Note:** Where applicable, remove the luggage cover to ease installation. See **Luggage Covers** (page 114).

1. Route the tether strap to the anchor point.



E87145

2. Push the child seat back firmly to engage the ISOFIX lower anchor points.
3. Tighten the tether strap in line with the child seat manufacturer's instructions.

## CHILD SEAT POSITIONING

### WARNINGS



See an authorised dealer for the latest details relating to our recommended child seats.

# Child Safety

## WARNINGS



Extreme Hazard! Do not use a rearward facing child seat on a seat protected by an air bag in front of it!



When using a child seat with a support leg, the support leg must rest securely on the floor.



When using a child seat with a seat belt, make sure that the seat belt is not slack or twisted.

## WARNINGS



The child seat must rest tightly against the vehicle seat. It may be necessary to lift or remove the head restraint. See **Head Restraints** (page 76).

**Note:** When using a child seat on a front seat, always adjust the front passenger's seat to its fully rearward position. If it proves difficult to tighten the lap section of the seat belt without slack remaining, adjust the seatback to the fully upright position and raise the height of the seat. See **Seats** (page 76).

Seating positions	Mass group categories				
	0	0+	1	2	3
	Up to 22 lbs (10 kg)	Up to 29 lbs (13 kg)	20 - 40 lbs (9 - 18 kg)	33 - 55 lbs (15 - 25 kg)	46 - 79 lbs (22 - 36 kg)
Front passenger's seat with airbag <b>ON</b>	X	X	UF <sup>1</sup>	UF <sup>1</sup>	UF <sup>1</sup>
Front passenger's seat with airbag <b>OFF</b>	U <sup>1</sup>	U <sup>1</sup>	U <sup>1</sup>	U <sup>1</sup>	U <sup>1</sup>
Rear seats	U	U	U	U	U

X Not suitable for children in this mass group.

U Suitable for universal category child seats approved for use in this mass group.

U<sup>1</sup> Suitable for universal category child seats approved for use in this mass group. However, we recommend that you secure children in a government approved child seat, on the rear seat.

UF<sup>1</sup> Suitable for universal category forward facing child seats approved for use in this mass group. However, we recommend that you secure children in a government approved child seat, on the rear seat.

# Child Safety

## ISOFIX Child Seats

Seating positions		Mass group categories	
		O+	1
		Rear facing	Forward facing
		Up to 29 lbs (13 kg)	20 - 40 lbs (9 - 18 kg)
Front seat	Size class	Not ISOFIX equipped	
	Seat type		
Rear outboard seat ISOFIX	Size class	C, D, E*	A, B, B1*
	Seat type	IL**	IL, IUF***
Rear centre seat	Size class	Not ISOFIX equipped	
	Seat type		

IL Suitable for particular ISOFIX child seat systems of the semi-universal category. Please see child seat systems suppliers' vehicle recommendation lists.

IUF Suitable for ISOFIX forward facing child seat systems of universal category approved for use in this mass group and ISOFIX size class.

\*The ISOFIX size class for both universal and semi-universal child seat systems is defined by the capital letters A to G. These identification letters are displayed on the ISOFIX child seat.

\*\*At time of publishing the recommended Group O+ ISOFIX baby safety seat is the Britax Romer Baby Safe. See an authorised dealer for the latest details relating to our recommended child seats.

\*\*\*At time of publishing the recommended Group 1 ISOFIX child seat is the Britax Romer Duo. See an authorised dealer for the latest details relating to our recommended child seats.

# Child Safety

---

## CHILD SAFETY LOCKS

### WARNING



You cannot open the doors from inside if you have put the child safety locks on.

---

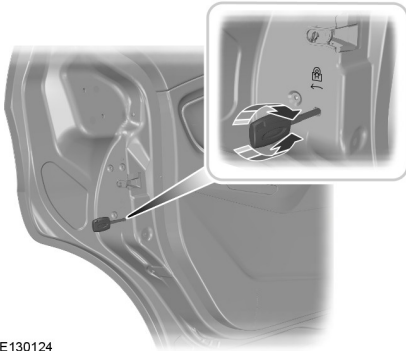

E130124

### Left-Hand Side

Turn anticlockwise to lock and clockwise to unlock.

### Right-Hand Side

Turn clockwise to lock and anticlockwise to unlock.

# Seat Belts

## FASTENING THE SEAT BELTS

### WARNINGS

 Insert the tongue into the buckle until you hear a distinct click. You have not fastened the seat belt correctly if you do not hear a click.

 Make sure that your seat belt is securely stored away and is not outside your vehicle when closing the door.

Press the red button on the buckle to release the belt. Let it retract completely and smoothly.

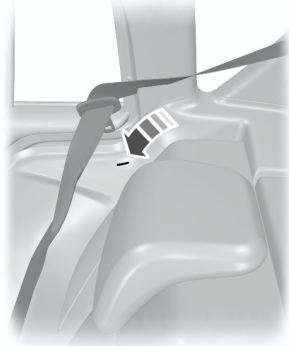

E144590

**Note:** When not in use, place the seat belts in to the slots on the outboard trim.

## Using Seat Belts During Pregnancy



E74124

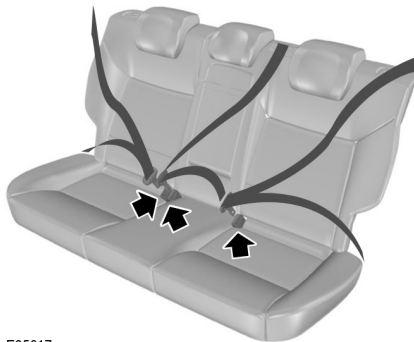

E85817

Pull the belt out steadily. It may lock if you pull it sharply or if your vehicle is on a slope.

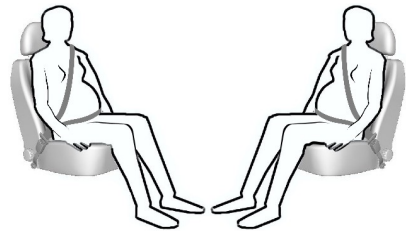

E68587

### WARNING

 Position the seat belt correctly for your safety and that of your unborn child. Do not use only the lap strap or the shoulder strap.

# Seat Belts

---

Pregnant women should always wear their seat belt. The lap belt portion of a combination lap and shoulder belt should be positioned low across the hips below the belly and worn as tight as comfort will allow. The shoulder belt should be positioned to cross the middle of the shoulder and the centre of the chest.

## SEAT BELT MINDER

### WARNING



The system will only provide protection when you use the seat belt correctly.

---

The warning lamp illuminates and an audible warning will sound when the following conditions have been met:

- The front seat belts have not been fastened.
- Your vehicle exceeds a relatively low speed.

It will also illuminate when a front seat belt is unfastened when your vehicle is moving.

If you do not fasten your seat belt both the audible and visual warnings will switch off automatically after approximately five minutes.

### Turning the Seat Belt Minder Off

See an authorised dealer.

# Supplementary Restraints System

## PRINCIPLE OF OPERATION

### WARNINGS

 Do not modify the front of your vehicle in any way. This could adversely affect deployment of the airbags.

 Original text according to ECE R94.01: Extreme Hazard! Do not use a rearward facing child restraint on a seat protected by an airbag in front of it!

 Wear a seat belt and keep sufficient distance between yourself and the steering wheel. Only when you use the seat belt properly, can it hold you in a position that allows the airbag to achieve its optimum effect. See **Sitting in the Correct Position** (page 76).

 Have repairs to the steering wheel, steering column, seats, airbags and seat belts carried out by an authorised dealer.

 Keep the areas in front of the airbags free from obstruction. Do not affix anything to or over the airbag covers.

 Do not puncture the seat with pins, needles or other pointed objects. This could cause damage and adversely affect deployment of the airbags.

 Use seat covers designed for seats with side airbags. Have these fitted by an authorised dealer.

**Note:** You will hear a loud bang and see a cloud of harmless powdery residue if an airbag deploys. This is normal.

**Note:** Only wipe airbag covers with a damp cloth.

## DRIVER AIRBAG

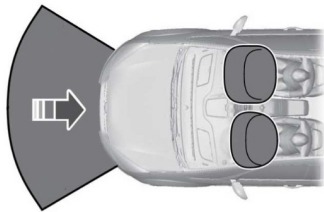

E151127

The airbag will deploy during significant frontal or near-frontal collisions. The airbag will inflate within a few thousandths of a second and deflate on contact with the occupant, thus cushioning forward body movement. During minor frontal collisions, overturns, rear collisions and side collisions, the airbag will not deploy.

## PASSENGER AIRBAG

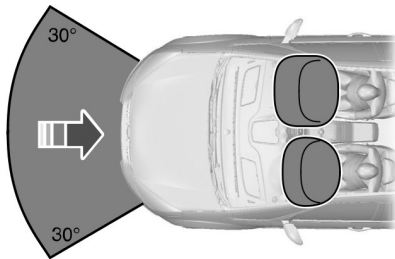

E74302



# Supplementary Restraints System

The airbag will deploy during significant frontal collisions or collisions that are up to 30 degrees from the left or the right. The airbag will inflate within a few thousandths of a second and deflate on contact with the occupant, thus cushioning forward body movement. During minor frontal collisions, overturns, rear collisions and side collisions, the airbag will not deploy.

## Switching the Passenger's Airbag Off

### WARNING



You must switch the airbag off when using a rearward facing child seat on the front seat.



E71313



A

B

E71312

A Switch off

B Switch on

Turn the switch to position A.

When you switch the ignition on, check that the airbag deactivation warning lamp illuminates.

## Switching the Passenger's Airbag On

### WARNING



You must switch the airbag on when you are not using a child seat on the front seat.

Turn the switch to position B.

## SIDE AIRBAGS

### WARNING



Use seat covers designed for seats with side airbags. Have these fitted by an authorised dealer.



E72658

The airbags are located inside the seatback of the front seats. There is a label attached to the side of the seatback to indicate this.

The airbag will deploy during significant lateral collisions. It will also deploy during significant frontal angled collisions. The airbag will not deploy in minor lateral and frontal collisions, rear collisions, or overturns.

# Supplementary Restraints System

## KNEE AIRBAG

### WARNING



Do not attempt to open the airbag cover.

The airbag will deploy during frontal collisions or collisions that are up to 30 degrees from the left or the right. The airbag will inflate within a few thousandths of a second and deflate on contact with the occupants, thus providing a cushion between the driver's knees and the steering column. During overruns, rear collisions and side collisions, the knee airbag will not deploy.

For item location: See **At a Glance** (page 8).

**Note:** *The airbag has a lower deployment threshold than the front airbags. During a minor collision, it is possible that only the knee airbag will deploy.*

The curtain airbag will deploy during significant lateral collisions. It will also deploy during significant frontal angled collisions. The curtain airbag will not deploy in minor lateral and frontal collisions, rear collisions, or overruns.

## SIDE CURTAIN AIRBAGS

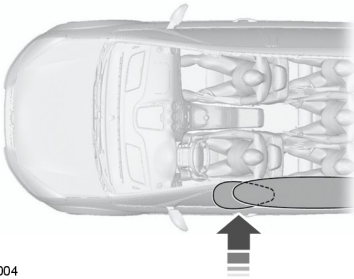

E75004

Curtain airbags are located over the front and rear side windows.

# Keys and Remote Controls

---

## GENERAL INFORMATION ON RADIO FREQUENCIES

**Note:** *Changes or modifications not expressly approved by the party responsible for compliance could void the user's authority to operate the equipment.*

The typical operating range for your transmitter is approximately 33 feet (10 metres). A decrease in operating range could be caused by:

- weather conditions
- nearby radio towers
- structures around your vehicle
- other vehicles parked next to your vehicle.

The radio frequency used by your remote control can also be used by other short distance radio transmissions (e.g. amateur radios, medical equipment, wireless headphones, remote controls and alarm systems). If the frequencies are jammed, you will not be able to use your remote control. You can lock and unlock the doors with the key.

**Note:** *Make sure your vehicle is locked before leaving it unattended.*

**Note:** *If you are in range, the remote control will operate if you press any button unintentionally.*

## REMOTE CONTROL

You can program a maximum of eight remote controls to your vehicle. This includes any that were supplied with your vehicle. The remote controls must remain inside your vehicle during the programming procedure. Fasten the front seat belts and close all doors to make sure that conflicting chimes do not sound during programming.

## Programming a New Remote Control

1. Turn the ignition key from position **0** to position **II** four times within six seconds.
2. Turn the ignition to position **0**. A tone sounds to indicate that it is now possible to program a remote control.
3. Press any button on a new remote control within 10 seconds. A tone will sound as confirmation.
4. Repeat step three within 10 seconds for each new remote control. Do not remove the key from the ignition when pressing the button on the remote control.
5. Switch the ignition back on (position **II**) or wait for 10 seconds without programming another remote control to end the key programming. Only the remote controls which you have just programmed are now able to lock and unlock your vehicle.

## Reprogramming the Unlocking Function

**Note:** *When you press the unlock button either all the doors are unlocked or only the driver's door and the tailgate are unlocked. Pressing the unlock button again unlocks all the doors.*

Press and hold the unlock and lock buttons on the remote control simultaneously for at least four seconds with the ignition off. The direction indicators will flash twice to confirm the change.

To return to the original unlocking function, repeat the process.

# Keys and Remote Controls

## Changing the Remote Control Battery



Make sure that you dispose of old batteries in an environmentally friendly way.

Seek advice from your local authority regarding recycling.

## Remote Control With a Folding Key Blade

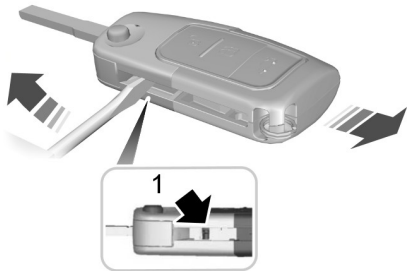

E74383

1. Insert a screwdriver as far as possible into the slot on the side of the remote control, push it toward the key blade and remove the key blade.

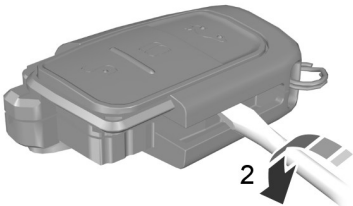

E74384

2. Twist the screwdriver in the position shown to start separating the two halves of the remote control.

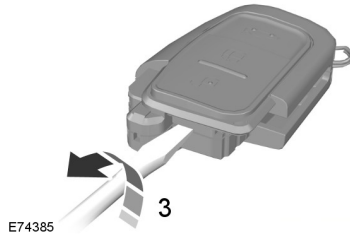

E74385

3. Twist the screwdriver in the position shown to separate the two halves of the remote control.

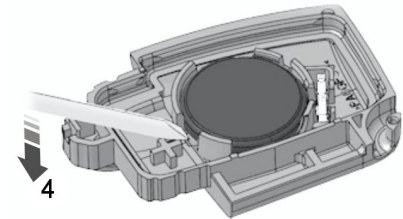

E126280

**Note:** Do not touch the battery contacts or the printed circuit board with the screwdriver.

4. Carefully remove the battery with the screwdriver.
5. Install a new battery (3V CR 2032) with the + facing downwards.
6. Assemble the two halves of the remote control.
7. Install the key blade.

# Keys and Remote Controls

## Remote Control Without a Folding Key Blade

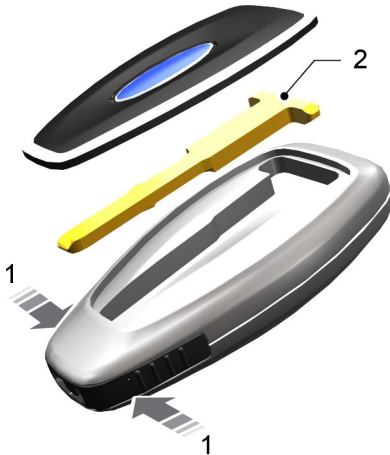

E87964

1. Press and hold the buttons on the edges to release the cover. Carefully remove the cover.
2. Remove the key blade.

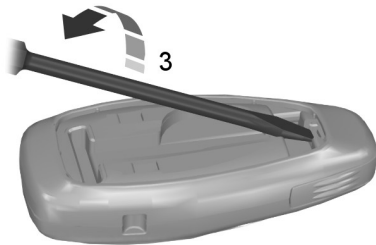

E105362

3. Twist the screwdriver in the position shown to start separating the two halves of the remote control.



E119190

4. Twist the screwdriver in the position shown to separate the two halves of the remote control.

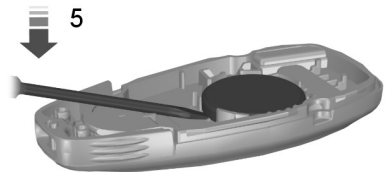

E125860

**Note:** Do not touch the battery contacts or the printed circuit board with the screwdriver.

5. Carefully remove the battery with the screwdriver.
6. Install a new battery (3V CR 2032) with the + facing downwards.
7. Assemble the two halves of the remote control.
8. Install the key blade.

# Keys and Remote Controls

---

## **REPLACING A LOST KEY OR REMOTE CONTROL**

Replacement or additional keys or remote controls can be purchased from an authorised dealer. Your dealer can program the remote controls for your vehicle or you may be able to program them yourself. See **Remote Control** (page 25).

To re-program the passive anti-theft system see an authorised dealer.

# Locks

## LOCKING AND UNLOCKING

### Power Door Locks

- Press the button once. The doors will lock.
- Press the button again. The doors will unlock.

For item location: See **At a Glance** (page 8).

### Remote Control

The remote control can be used any time your vehicle is not running.

### Unlocking the Doors

**Note:** You can unlock the driver's door with the key. Use the key when the remote control is not functioning.

**Note:** When you lock your vehicle for several weeks, the remote control will be switched off. Your vehicle must be unlocked and the engine started using the key. Unlocking and starting your vehicle once will enable the remote control.



Press the button to unlock the driver's door.

Press the button again within three seconds to unlock all doors. The direction indicators will flash.

### Reprogramming the Unlocking Function

You can reprogram the unlocking function so that only the driver's door is unlocked. See **Remote Control** (page 25).

### Locking the Doors



Press the button to lock all the doors. The direction indicators will illuminate.

Press the button again within three seconds to confirm that all the doors are closed. The doors will lock again, and the direction indicators will illuminate if all the doors and the luggage compartment are closed.

**Note:** If any door or the luggage compartment is not closed, or if the bonnet is not closed on vehicles equipped with an anti-theft alarm or remote start, the lamps will not flash.

### Double Locking

#### WARNING



Do not use double locking when passengers or animals are inside your vehicle. You will not be able to unlock the doors from the inside if you have double locked them.

Double locking is a theft protection feature that prevents someone from opening the doors from the inside. You can only double lock the doors if they are all closed.



Press the button twice within three seconds.

### Automatic Relocking

The doors will relock automatically if you do not open a door within 45 seconds of unlocking the doors with the remote control. The door locks and the alarm will return to their previous state.

### Locking and Unlocking the Doors From Inside



Press the button. For item location: See **At a Glance** (page 8).

### Locking and Unlocking the Doors With the Key

**Note:** Do not leave your keys in your vehicle.

# Locks

## Locking With the Key

Turn the top of the key toward the front of your vehicle.

## Double Locking With the Key

Turn the key to the lock position twice within three seconds.

## Unlocking With the Key

**Note:** *If the child safety locks are on and you pull the interior handle, you will only turn off the emergency locking, not the child safety lock. You can only open the doors using the external door handle.*

**Note:** *If the doors have been unlocked using this method, the doors must be locked individually until the central locking function has been repaired.*

Unlock the driver's door using the key. You can unlock all other doors individually by pulling the interior door handles.

**Note:** *When the central locking function fails to operate, lock the doors individually using the key in the position shown.*

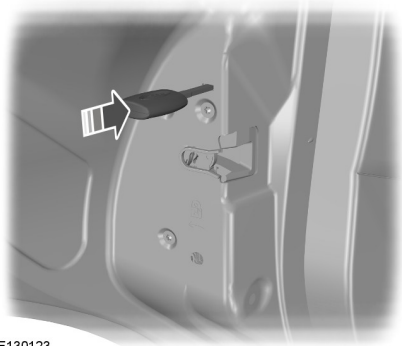

E130123

Push to lock.

## SLIDING DOOR



E145826

When the rear doors are fully open, make sure that you do not step on the cable or mechanism at the base of the door aperture.



E142053



# Locks



## MANUAL LIFTGATE

### WARNINGS



It is extremely dangerous to ride in the cargo area, inside or outside of your vehicle. In a collision, people riding in these areas are more likely to be seriously injured or killed. Do not allow people to ride in any area of your vehicle that does not have seats and seat belts. Make sure everyone in your vehicle is in a seat and using a seat belt correctly.



Make sure that the liftgate is closed to prevent exhaust fumes from being drawn into your vehicle. This will also prevent passengers and cargo from falling out. If you must drive with the liftgate door open, keep your vehicle well ventilated so outside air does not enter your vehicle.

**Note:** Be careful when opening or closing the liftgate in a garage or other enclosed area to avoid damaging the liftgate.

**Note:** Do not hang anything (bike rack, etc.) from the spoiler, glass or liftgate. This could damage the liftgate and its components.

**Note:** Do not leave the liftgate open while driving. This could damage the liftgate and its components.

## Opening and Closing the Liftgate

### To Open the Liftgate

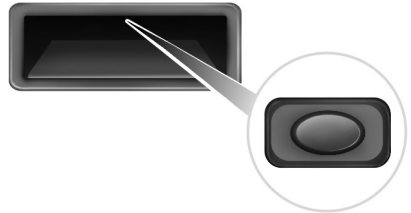

E138632

Press the button located in the top of the liftgate pull cup handle to unlatch the liftgate, then pull on the outside handle.

### Opening With the Remote Control



Press the button twice within three seconds.

### To Close the Liftgate

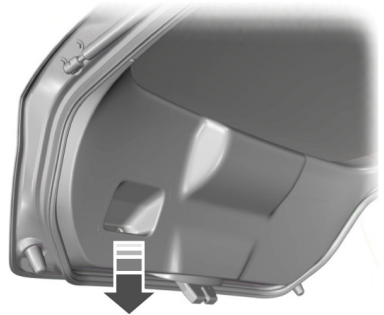

E89132

A recessed grip is located inside the liftgate to help with closing.

# Locks

## KEYLESS ENTRY

### General Information

#### WARNING



The system may not function if the key is close to metal objects or electronic devices such as mobile phones.

The system will not function if:

- Your vehicle battery has no charge.
- The passive key frequencies are jammed.
- The passive key battery is flat.

**Note:** *If the system does not function, you will need to use the key blade to lock and unlock your vehicle.*

The system allows you to operate your vehicle without the use of a key or remote control.

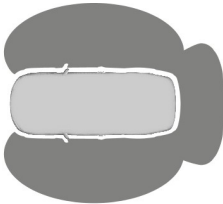

E78276

Passive locking and unlocking requires a valid passive key to be located within one of the three external detection ranges. These are located approximately five feet (one and a half metres) from the front door handles and the liftgate.

### Passive Key

Your vehicle can be locked and unlocked with the passive key. You can use the passive key as a remote control. See **Locking and Unlocking** (page 29).

## Locking Your Vehicle

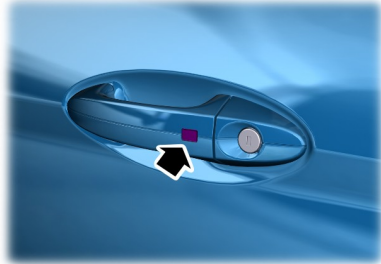

E87384

#### WARNING



Your vehicle does not lock itself automatically. If you do not press a locking button your vehicle will remain unlocked.

Locking buttons are located on each of the front doors.

For central locking and to arm the alarm, press a locking button once.

For double locking and to arm the alarm, press a locking button twice within three seconds.

**Note:** *Your vehicle will remain locked for approximately three seconds. When the delay period is over, you can open the doors again, provided the passive key is within the respective detection range.*

Two short flashes of the direction indicators confirms that all the doors and the liftgate have been locked and that the alarm has been armed.

### Liftgate

**Note:** *The liftgate cannot be closed and will pop back up if the passive key is located inside the luggage compartment with the doors locked.*

# Locks

**Note:** If a second valid passive key is located within the liftgate detection range, the liftgate can be closed.

## Unlocking Your Vehicle

**Note:** When your vehicle remains locked for longer than three days, the system will enter an energy-saving mode. This is to prevent your vehicle battery running out of charge. When your vehicle is unlocked while in this mode, the reaction time of the system may be a little longer than normal. To exit the energy-saving mode, unlock your vehicle.

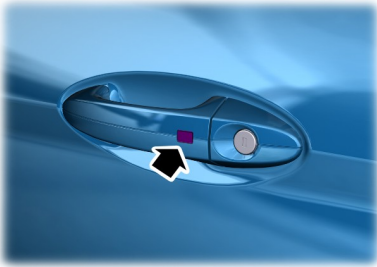

E87384

Press a locking button once.

**Note:** A valid passive key must be located within the detection range of that door.

One long flash of the direction indicators confirms that all the doors and the liftgate have been unlocked and that the alarm has been disarmed.

## Unlocking Only the Driver's Door

If the unlocking function is reprogrammed so that only the driver's door and the liftgate are unlocked. See **Remote Control** (page 25). Note the following:

If the driver's door is the first door which is opened, the other doors will remain locked. All the other doors can be unlocked from inside your vehicle by pressing the unlock button on the instrument panel. For item location: See **At a Glance** (page 8). Doors can be unlocked individually by pulling the interior door handles on those doors.

If the front passenger's door is the first door which is opened, all the doors and the liftgate will be unlocked.

## Disabled Keys

Any keys left inside your vehicle interior when it is locked will be disabled.

You cannot use a disabled key to switch the ignition on or start the engine.

You must enable all passive keys again in order to use them.

To enable all your passive keys, unlock your vehicle using a passive key or the remote control unlocking function.

All passive keys will then be enabled if you switch the ignition on or you start your vehicle with a valid key.

# Locks

---

## Locking and Unlocking the Doors With the Key Blade

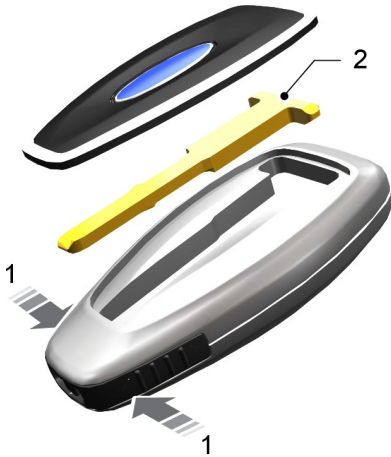

E87964

1. Carefully remove the cover.
2. Remove the key blade and insert it into the lock.

**Note:** Only the driver's door handle has a lock cylinder.

# Security

## PASSIVE ANTI-THEFT SYSTEM

### Principle of Operation

The engine immobiliser is a theft protection system that prevents someone from starting the engine with an incorrectly coded key.

### Coded Keys

**Note:** Do not shield your keys with metal objects. This may prevent the receiver from recognising your key as a valid one.

**Note:** Have all of your remaining keys erased and recoded if you lose a key. Ask an authorised dealer for further information. Have replacement keys recoded together with your existing keys.

If you lose a key, you can obtain a replacement from an authorised dealer. If possible, provide them with the key number from the tag provided with the original keys. You can also obtain additional keys from an authorised dealer.

### Arming the Engine Immobiliser

After you switch the ignition off the engine immobiliser will arm automatically after a short time.

### Disarming the Engine Immobiliser

The engine immobiliser is disarmed automatically when you switch the ignition on with a correctly coded key.

When the indicator stays on, flashes for approximately one minute or repeatedly at irregular intervals, the key has not been recognised. Remove the key and try again.

If you are unable to start the engine with a correctly coded key, this indicates a malfunction. Have the immobiliser checked immediately.

## ANTI-THEFT ALARM

### Alarm System

Your vehicle may have one of the following alarm systems:

- Perimeter alarm.
- Perimeter alarm with interior sensors.
- Category one alarm with interior sensors and battery back-up sounder.

### Perimeter Alarm

The perimeter alarm is a deterrent against unauthorised access to your vehicle through the doors and the bonnet. It also protects the audio unit.

### Interior Sensors



E71401

### WARNINGS



Do not cover up the interior lamp unit sensors.



Do not arm the alarm with full guard if passengers, animals or other moving objects are inside your vehicle.

The sensors act as a deterrent against unauthorised intrusion by sensing any movement within your vehicle.

# Security

---

## Battery Back-up Sounder

The battery back-up sounder is an extra alarm system which will sound a siren when the alarm is triggered. When you lock your vehicle the system is armed. The sounder has its own battery and will sound an alarm siren even if someone disconnects your vehicle battery or the battery back-up sounder itself.

## Triggering the Alarm

Once armed, the alarm is triggered in any of the following ways:

- If someone opens a door, the liftgate or the hood without a valid key or remote control.
- If someone removes the audio or navigation system.
- If you switch the ignition on without a valid key.
- If the interior sensors detect movement within your vehicle.
- On vehicles with a battery back-up sounder, if someone disconnects your vehicle battery or the battery back-up sounder itself.

If the alarm is triggered, the alarm horn will sound for 30 seconds and the hazard warning flasher will flash for five minutes.

Any further attempts to perform one of the above will trigger the alarm again.

## Full and Reduced Guard

### Full Guard

Full guard is the standard setting.

In full guard, the interior sensors are on when you arm the alarm.

**Note:** *This may result in false alarms if animals or moving objects are inside your vehicle.*

### Reduced Guard

In reduced guard, the interior sensors are off when you arm the alarm.

**Note:** *You can set the alarm to reduced guard for the current ignition cycle only. The alarm will reset to full guard the next time you switch the ignition on.*

### Ask on Exit

You can set the information display to ask you each time which level of guard you wish to set.

If you select **Ask on Exit**, the message **Reduced guard?** appears in the information display each time you switch the ignition off. See **Information Messages** (page 62).

If you wish to arm the alarm with reduced guard, press the **OK** button when this message appears.

If you wish to arm the alarm with full guard, leave your vehicle without pressing the **OK** button.

### Selecting Full or Reduced Guard

**Note:** *Selecting **Reduced** does not set the alarm permanently to reduced guard. It sets it to reduced guard only for the current ignition cycle. If you regularly set the alarm to reduced guard, select **Ask on Exit**.*

You can select full or reduced guard using the information display. See **General Information** (page 58).

### Arming the Alarm

To arm the alarm, lock your vehicle. See **Locks** (page 29).

## Disarming the Alarm

### Vehicles Without Keyless Entry

#### **Perimeter Alarm**

Disarm and silence the alarm by unlocking the doors with the key and switching the ignition on with a correctly coded key or unlocking the doors with the remote control.

#### **Category One Alarm**

Disarm and silence the alarm by unlocking the doors with the key and switching the ignition on with a correctly coded key within 12 seconds or unlocking the doors with the remote control.

### Vehicles with Keyless Entry

**Note:** *A valid passive key must be located within the detection range of that door for keyless entry. See **Keyless Entry** (page 32).*

#### **Perimeter Alarm**

Disarm and silence the alarm by unlocking the doors and switching the ignition on or unlocking the doors with the remote control.

#### **Category One Alarm**

Disarm and silence the alarm by unlocking the doors and switching the ignition on within 12 seconds or unlocking the doors or the liftgate with the remote control.

# Steering Wheel

## ADJUSTING THE STEERING WHEEL

### WARNING

 Do not adjust the steering wheel when your vehicle is moving.

**Note:** Make sure that you are sitting in the correct position. See **Sitting in the Correct Position** (page 76).

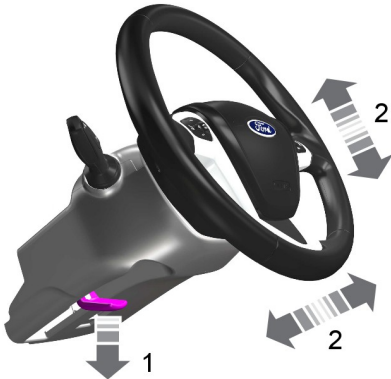

E95178

1. Unlock the steering column.
2. Adjust the steering wheel to the desired position.



E95179

3. Lock the steering column.

## AUDIO CONTROL

Select the required source on the audio unit.

You can operate the following functions with the control:

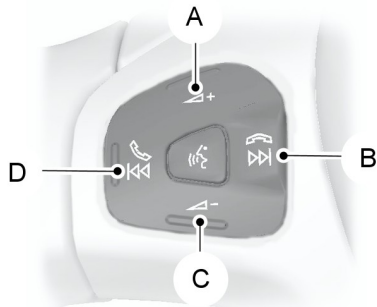

E141530

- A Volume up
- B Seek up, next or end call



# Steering Wheel

---

- C Volume down
- D Seek down, previous or accept call

## Seek, Next or Previous

Press the seek button to:

- tune the radio to the next or previous stored preset
- play the next or the previous track.

Press and hold the seek button to:

- tune the radio to the next station up or down the frequency band
- seek through a track.

## VOICE CONTROL

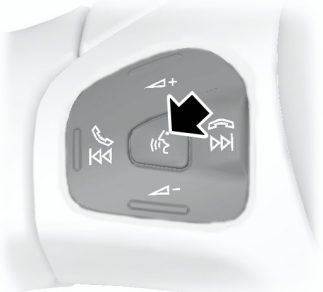

E141533

Press the button to select or deselect voice control. See **SYNC** (page 196).

## CRUISE CONTROL



E141961

See **Cruise Control** (page 109).

# Wipers and Washers

## WINDSCREEN WIPERS

**Note:** Fully defrost the windscreen before switching on the windscreen wipers.

**Note:** Make sure the windscreen wipers are switched off before entering a car wash.

**Note:** Install new wiper blades as soon as they begin to leave bands of water and smears on the windscreen.

**Note:** Do not operate the wipers on a dry windscreen. This may scratch the glass, damage the wiper blades or cause the wiper motor to burn out. Always use the windscreen washers before wiping a dry windscreen.

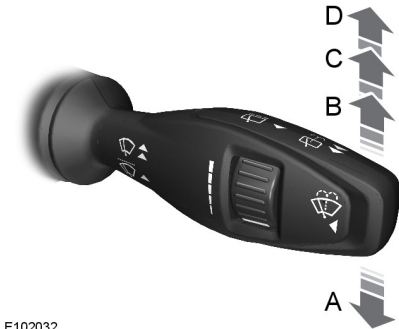

E102032

- A Single wipe
- B Intermittent wipe
- C Normal wipe
- D High speed wipe

## Intermittent Wipe

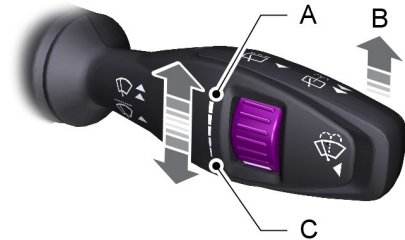

E102033

- A Short wipe interval
- B Intermittent wipe
- C Long wipe interval

Use the rotary control to adjust the intermittent wipe interval.

## Speed Dependent Wipers

When your vehicle speed increases, the interval between wipes will decrease.

## AUTOWIPERS

**Note:** Fully defrost the windscreen before switching on the windscreen wipers.

**Note:** Make sure the windscreen wipers are switched off before entering a car wash.

**Note:** Install new wiper blades as soon as they begin to leave bands of water and smears on the windscreen.

**Note:** If you switch autolamps on in conjunction with autowipers, dipped beam headlamps will illuminate automatically when the rain sensor activates the windscreen wipers continuously.

**Note:** Wet road conditions can cause unexpected wiping or smearing.

# Wipers and Washers

To reduce smearing we recommend the following:

- Lower the sensitivity of the autowipers.
- Switch to normal or high speed wipe.
- Switch the autowipers off.

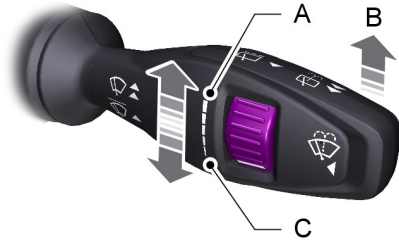

E102033

- A High sensitivity
- B On
- C Low sensitivity

The wipers will function when moisture is detected on the windscreen. The rain sensor will continue to monitor the amount of moisture on the windscreen and adjust the speed of the wipers automatically.

Use the rotary control to adjust the sensitivity of the rain sensor. With low sensitivity, the wipers will operate when the sensor detects a large amount of moisture on the windscreen. With high sensitivity, the wipers will operate when the sensor detects a small amount of moisture on the windscreen.

Keep the outside of the windscreen clean. Sensor performance will be affected if the area around the interior mirror is dirty. The rain sensor is very sensitive and the wipers may operate if dirt, mist or flies hit the windscreen.

## WINDSCREEN WASHERS

**Note:** Do not operate the washers when the washer reservoir is empty. This may cause the washer pump to overheat.



E102051

Push the button to operate the washers. They will operate for a maximum of 10 seconds. When you release the button, the wipers will operate for a short time.

## REAR WINDOW WIPER AND WASHERS

### Intermittent Wipe

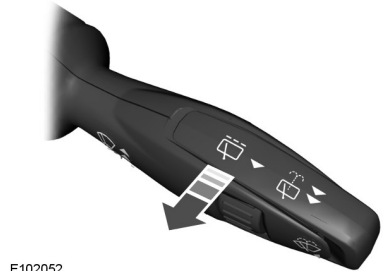

E102052

Pull the lever toward you.

# Wipers and Washers

---

## Reverse Gear Wipe

The rear wiper will turn on automatically when selecting reverse gear if:

- the rear wiper is not already switched on
- the wiper lever is in position A, B, C or D
- the front wiper is operating (when set to position B).

The rear wiper will follow the front wiper interval (at intermittent or normal speed).

## Rear Window Washer

**Note:** *Do not operate the washers when the washer reservoir is empty. This may cause the washer pump to overheat.*

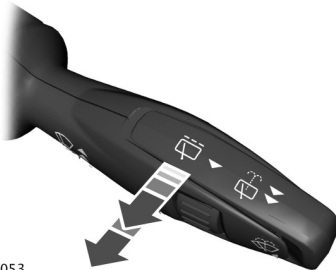

E102053

Pull the lever toward you to operate the washers. They will operate for a maximum of 10 seconds. When you release the lever, the wiper will operate for a short time.

# Lighting

## LIGHTING CONTROL

### Lighting Control Positions

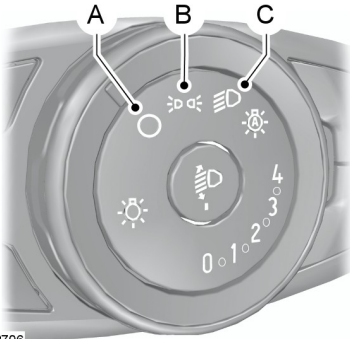

E132706

- A Off
- B Parking lamps, instrument panel lamps, licence plate lamps and rear lamps
- C Headlamps

### Parking Lamps

**Note:** Prolonged use of the parking lamps will cause the battery to run out of charge.

Switch the ignition off.

Turn the lighting control to position B.

### Main Beams



E101829

Pull the lever fully toward you to switch the main beams on.

Push the lever forward to switch the main beams off.

### Headlamp Flasher

Pull the lever toward you slightly and release it to flash the headlamps.

## AUTOLAMPS

**Note:** It may be necessary to switch your headlamps on manually in severe weather conditions.

**Note:** If you have autolamps on, you can only switch the main beam on once autolamps has switched the headlamps on.

**Note:** If you have autolamps on, you can only switch the front fog lamps on once autolamps has switched the headlamps on.

# Lighting



E132707

The headlamps will switch on and off automatically in low light situations or during inclement weather.

The headlamps will remain on for a period of time after you switch the ignition off. You can adjust the time delay using the information display controls. See **Information Displays** (page 58).

**Note:** *If you switch autolamps on in conjunction with autowipers, dipped beam headlamps will illuminate automatically when the rain sensor turns on the windscreen wipers continuously.*

## INSTRUMENT LIGHTING DIMMER

**Note:** *If you disconnect the battery or it loses charge, the illuminated components will switch to the maximum setting.*

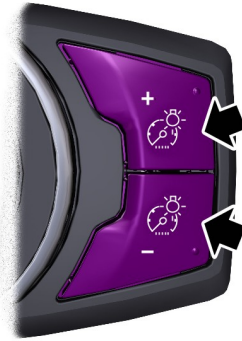

E132712

Press repeatedly or press and hold until the desired level is reached.

## HEADLAMP EXIT DELAY

After you switch the ignition off, you can switch the headlamps on by pulling the direction indicator lever toward you. You will hear a short tone. The headlamps will switch off automatically after three minutes with any door open or 30 seconds after the last door has been closed. You can cancel this feature by pulling the direction indicator toward you again or switching the ignition on.

# Lighting

## DAYTIME RUNNING LAMPS

### WARNING



Always remember to switch your headlamps on in low light situations or during inclement weather. The system does not turn on the tail lamps and may not provide adequate lighting during these conditions. Failure to switch the headlamps on under these conditions may result in a collision.

The system switches the headlamps on in low light situations.

To switch the system on:

1. Switch the ignition on.
2. Turn the lighting control to the off, autolamp or parking lamp position.
3. Make sure the transmission selector lever is not in position **P**.

## FRONT FOG LAMPS

### WARNING



Only use the front fog lamps when visibility is considerably restricted by fog, snow or rain.

**Note:** If you switch autolamps on, you can only switch the front fog lamps on once autolamps has switched the headlamps on.



E132709

Press the control to switch the fog lamps on or off.

You can switch the fog lamps on when the lighting control is in any position except off.

## REAR FOG LAMPS



E132710

### WARNINGS



Only use the rear fog lamps when visibility is restricted to less than 164 feet (50 metres).

# Lighting

## WARNINGS



Do not use the rear fog lamps when it is raining or snowing and visibility is more than 164 feet (50 metres).

Press the control to switch the fog lamps on or off.

You can switch the fog lamps on when either the front fog lamps or dipped beam headlamps are on.

## HEADLAMP LEVELLING

**Note:** Vehicles with Xenon headlamps have automatic headlamp levelling.

1. Press to release the pop out button.

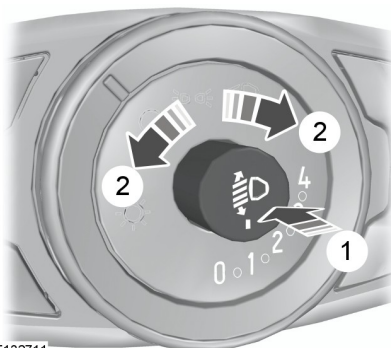

E132711

2. Rotate the button to the required setting.
3. Push the button to the closed position.

You can adjust the level of the headlamp beams according to your vehicle load.

## Recommended Headlamp Levelling Switch Positions

Load		Load in luggage compartment	Switch position
Front seats	Second row seats		
1-2	-	-	0
2	3	-	1.5
2	3	Max <sup>1</sup>	2.5
1	-	Max <sup>1</sup>	3.5

<sup>1</sup> See **Vehicle Identification Plate** (page 167).



# Lighting

## DIRECTION INDICATORS



E102016

Push the lever up or down to use the direction indicators.

**Note:** Tap the lever up or down to make the direction indicators flash three times to indicate a lane change.

## INTERIOR LAMPS

### Courtesy Lamp

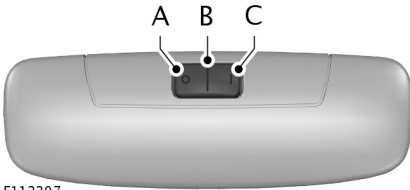

E112207

- A Off
- B Door contact
- C On

If you set the switch to position B, the courtesy lamp will illuminate when you unlock or open a door or the liftgate. If you leave a door open with the ignition switched off, the courtesy lamp will go off automatically after some time to prevent your vehicle battery from losing charge. To switch it back on, switch the ignition on for a short time.

The courtesy lamp will also illuminate when you switch the ignition off. It will go off automatically after a short time or when you start the engine.

If you set the switch to position C with the ignition switched off, the courtesy lamp will illuminate. It will go off automatically after a short time to prevent your vehicle battery from losing charge. To switch it back on, switch the ignition on for a short time.

### Reading Lamps



E112208

If you switch the ignition off, the reading lamps will go off automatically after some time to prevent your vehicle battery from discharging. To switch them back on, switch the ignition on for a short time.

# Windows and Mirrors

## POWER WINDOWS

### WARNINGS



Do not leave children unattended in the vehicle and do not let them play with the power windows. They may seriously injure themselves.



When closing the power windows, you should verify they are free of obstructions and make sure that children and pets are not in the proximity of the window openings.

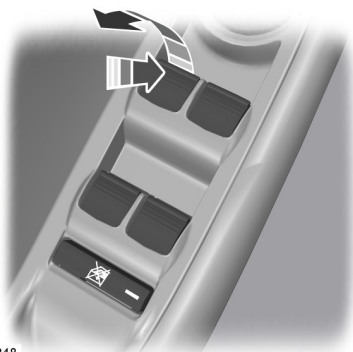

E70848

**Note:** You may hear a rumbling noise when just one of the windows are open. Lower the opposite window slightly to reduce this noise.

Press the switch to open the window.

Lift the switch to close the window.

### One-Touch Down (If Equipped)

Press the switch fully and release it. Press or lift it again to stop the window.

### One-Touch Up (If Equipped)

Lift the switch fully and release it. Press or lift it again to stop the window.

## Window Lock



E70850

Press the control to lock or unlock the rear window controls. It will illuminate when the rear window controls are locked.

### Bounce-Back (If Equipped)

The window will stop automatically while closing. It will reverse some distance if there is an obstacle in the way.

### Overriding the Bounce-Back Feature

Proceed as follows to override this protection feature when there is a resistance, e.g. in winter:

1. Close the window twice until it reaches the point of resistance and let it reverse.
2. Close the window a third time to the point of resistance. The bounce-back feature is now disabled and you can close the window manually. The window will go past the point of resistance and you can close it fully.

Contact your authorised dealer as soon as possible if the window does not close after the third attempt.

# Windows and Mirrors

## Resetting the Bounce-Back Feature

### WARNING



The bounce-back function remains deactivated until you have reset the memory.

If you have disconnected the battery, you must reset the bounce-back memory separately for each window.

1. Lift and hold the switch until the window is fully closed.
2. Release the switch.
3. Lift the switch again for one more second.
4. Press and hold the switch until the window is fully open.
5. Release the switch.
6. Lift and hold the switch until the window is fully closed.
7. Open the window and then try to close it automatically.
8. Reset and repeat the procedure if the window does not close automatically.

### Accessory Delay (If Equipped)

You can use the window switches for several minutes after you have switched the ignition off or until either front door is opened.

## EXTERIOR MIRRORS

### Power Exterior Mirrors

### WARNING



Do not adjust the mirrors when your vehicle is moving.

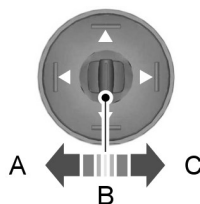

E70846

- A Left-hand mirror
- B Off
- C Right-hand mirror

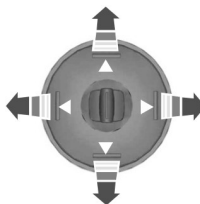

E70847

Press the arrows to adjust the mirror.

### Electric Folding Mirrors

#### Automatic Folding and Unfolding

**Note:** If the mirrors have been folded using the manual fold button they can only be unfolded using the manual fold button.

The mirrors will fold automatically when you lock your vehicle with the key, the remote control or a keyless entry system request. The mirrors will unfold when you unlock your vehicle with the key, the remote control, a keyless entry system request, the driver's interior door handle or starting the engine.

#### Manual Folding and Unfolding

**Note:** You can only fold the mirrors when the mirror switch is set to position B off.

The electric folding mirrors operate with the ignition on.

# Windows and Mirrors

**Note:** You can operate the mirrors (mirror tilting and folding) for several minutes after you switch the ignition off. If you open a door you can no longer operate the mirrors.



E144552

Press the downward arrow to fold or unfold the mirrors.

If you press the switch again while the mirrors are moving, they will stop and reverse the direction of movement.

**Note:** When the mirrors are operated often during a short period of time, the system may become inoperable for a period of time to prevent damage due to overheating.

## Fold-Away Exterior Mirrors

Push the mirror toward the door window glass. Make sure that you fully engage the mirror in its support when returning it to its original position.

## INTERIOR MIRROR

### WARNING



Do not adjust the mirror when your vehicle is moving.

**Note:** Do not clean the housing or glass of any mirror with harsh abrasives, fuel or other petroleum or ammonia-based cleaning products.

You can adjust the interior mirror to your preference. Some mirrors also have a second pivot point. This lets you move the mirror head up or down and from side to side.

Pull the tab below the mirror toward you to reduce glare at night.

## Auto-Dimming Mirror (If Equipped)

**Note:** Do not block the sensors on the front and back of the mirror. Mirror performance may be affected. A rear centre passenger or raised rear centre head restraint may also block light from reaching the sensor.

The mirror will dim automatically to reduce glare when bright lights are detected from behind your vehicle. It will automatically return to normal reflection when you select reverse gear to make sure you have a clear view when reversing.

## CHILDMINDER MIRROR



E75192

# Windows and Mirrors

## GLOBAL OPENING AND CLOSING

You can also operate the power windows with the ignition off using the global opening and global closing function.

**Note:** *Global opening will only operate for a short period of time after you have unlocked your vehicle using the remote control.*

**Note:** *Global closing will only operate if you have set the memory correctly for each window.* See **Power Windows** (page 48).

### Global Opening

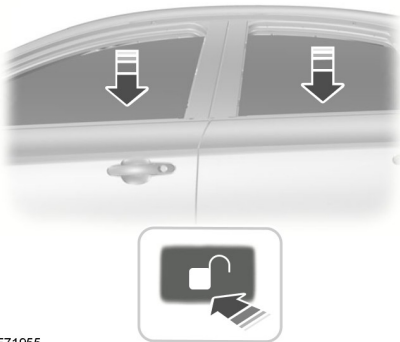

E71955

To open all the windows:

1. Press and release the remote control unlock button.
2. Press and hold the remote control unlock button for at least three seconds.

Press the lock or unlock button to stop the opening function.

## Global Closing

### Vehicles Without Keyless Entry

#### WARNING



Take care when using global closing. In an emergency, press the lock or unlock button immediately to stop.

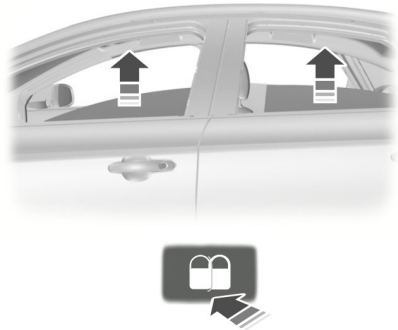

E71956

To close all the windows, press and hold the remote control lock button for at least three seconds. Press the lock or unlock button to stop the closing function. The bounce-back function is also on during global closing.

### Vehicles With Keyless Entry

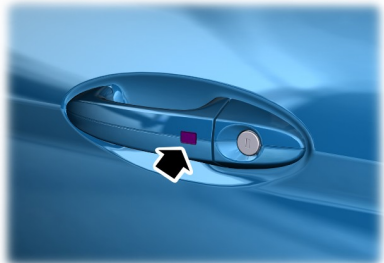

E87384

# Windows and Mirrors

---

## WARNING



Take care when using global closing. In an emergency, touch a door handle lock sensor to stop.

---

**Note:** *Global closing can be switched on using the driver's door handle. Global opening and closing can also be switched on using the buttons on the passive key.*

To close all the windows, press and hold the driver's door handle for at least three seconds. The bounce-back function is also on during global closing.

# Instrument Cluster

## GAUGES

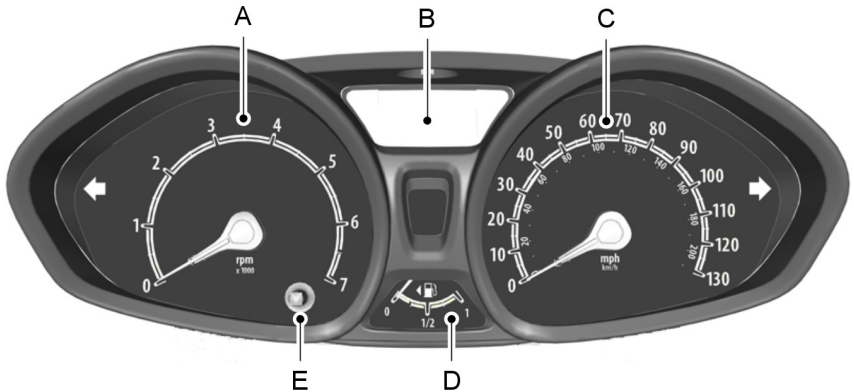

E102660

- A Tachometer
- B Information display
- C Speedometer
- D Fuel gauge
- E Tripmeter reset button

## Fuel Gauge

Switch the ignition on. The fuel gauge will indicate approximately how much fuel is left in the fuel tank. The fuel gauge may vary slightly when your vehicle is moving or on a gradient. The arrow adjacent to the fuel pump symbol indicates on which side of your vehicle the fuel filler door is located.

## WARNING LAMPS AND INDICATORS

The following warning lamps and indicators will illuminate when you switch the ignition on.

- Anti-lock braking system
- Airbag
- Brake system
- Coolant temperature
- Doors ajar
- Engine
- Frost
- Ignition
- Oil pressure
- Power steering
- Stability control

## Instrument Cluster

---

When a warning lamp or indicator does not illuminate once you have switched the ignition on, it indicates a malfunction. Have the system checked by an authorised dealer.

### Anti-lock Braking System Warning Lamp



If it illuminates when you are driving, this indicates a malfunction. You will continue to have normal braking (without anti-lock braking system). Have the system checked by an authorised dealer as soon as possible.

### Brake System Warning Lamp



It illuminates when you apply the parking brake or when the brake fluid level is low.

#### WARNING



Reduce your speed gradually and stop your vehicle as soon as it is safe to do so. Use your brakes with care.

If it illuminates when you are driving, check that the parking brake is not applied. If the parking brake is not applied, this indicates a malfunction. Have the system checked by an authorised dealer immediately.

### Coolant Temperature Warning Lamp

#### WARNING



Do not resume your journey if it illuminates despite the level being correct. Have the system checked by an authorised dealer immediately.



If it stays on after starting or illuminates when driving, this indicates a malfunction. Stop your vehicle as soon as it is safe to do so and switch the engine off. Check the coolant level. See **Engine Coolant Check** (page 140).

### Cruise Control Indicator



It will illuminate when you have set a speed using the cruise control system. See **Using Cruise Control** (page 109).

### Direction Indicator



Flashes during operation. A sudden increase in the rate of flashing warns of a failed indicator bulb. See **Changing a Bulb** (page 143).

### Door Ajar Warning Lamp



Illuminates when you switch the ignition on and remains on if any door, the bonnet or the liftgate is not closed properly.

### Engine Warning Lamps



Malfunction Indicator Lamp



Powertrain Warning Lamp



# Instrument Cluster

## All Vehicles

If either lamp illuminates when the engine is running, this indicates a malfunction. The engine will continue to run but it may have limited power. If it flashes when you are driving, reduce the speed of your vehicle immediately. If it continues to flash, avoid heavy acceleration or deceleration. Have the system checked by an authorised dealer immediately.

### WARNING



Have this checked immediately.

If both lamps illuminate together, stop your vehicle as soon as it is safe to do so (continued use may cause reduced power and cause the engine to stop). Switch the ignition off and attempt to restart the engine. If the engine restarts have the system checked by an authorised dealer immediately. When the engine does not restart have your vehicle checked before continuing your journey.

## Front Airbag Warning Lamp



If it illuminates when you are driving, this indicates a malfunction. Have the system checked by an authorised dealer.

## Front Fog Lamp Indicator



It will illuminate when you switch the front fog lamps on.

## Frost Warning Lamp

### WARNING



Even if the temperature rises to above +39°F (4°C) there is no guarantee that the road is free of hazards caused by inclement weather.



It will illuminate and glow orange when the outside air temperature is between 39°F (4°C) and 32°F (0°C). It will glow red when the temperature is below 32°F (0°C).

## Glow Plug Indicator



If it illuminates, wait until it extinguishes before starting.

## Headlamp Indicator



It will illuminate when you switch the headlamp dipped beam or the side and rear lamps on.

## Main Beam Indicator



It will illuminate when you switch the headlamp main beam on. It will flash when you use the headlamp flasher.

## Ignition Warning Lamp



If it illuminates when driving, this indicates a malfunction. Switch off all unnecessary electrical equipment. Have the system checked by an authorised dealer immediately.

## Low Fuel Level Warning Lamp



If it illuminates, refuel as soon as possible.

## Low Tyre Pressure Warning Lamp



It will illuminate when the tyre pressure is low. See **Tyre Pressure Monitoring System** (page 159).

# Instrument Cluster

## Message Centre Indicator



It will illuminate when a new message is stored in the information display. See

**Information Messages** (page 62).

## Oil Pressure Warning Lamp

### WARNING



Do not resume your journey if it illuminates despite the level being correct. Have the system checked by an authorised dealer immediately.



If it stays on after starting or illuminates when driving, this indicates a malfunction. Stop your vehicle as soon as it is safe to do so and switch the engine off. Check the engine oil level. See **Engine Oil Check** (page 139).

## Power Steering Warning Lamp



Illuminates to indicate a malfunction of the power steering system. You will continue to have full steering but will need to exert greater force on the steering wheel. Have the system checked by an authorised dealer as soon as possible.

## Rear Fog Lamp Indicator



It will illuminate when you switch the rear fog lamps on.

## Seat Belt Minder Warning Lamp



It will illuminate when a seat belt is not fastened. See **Seat Belt Minder** (page 21).

## Shift Indicator



It will illuminate to inform you that shifting to a higher gear may give better fuel economy and lower CO<sub>2</sub> emissions. It will not illuminate during periods of high acceleration, braking or when the clutch pedal is pressed.

## Stability Control Indicator



While driving, it flashes when the system is operating. After you switch the ignition on, if it does not illuminate or illuminates continuously while driving, this indicates a malfunction. During a malfunction, the system switches off. Have the system checked by an authorised dealer as soon as possible.

If you switch the electronic stability program off, the warning lamp will illuminate. The lamp will go out when you switch the system back on or when you switch the ignition off.

## AUDIBLE WARNINGS AND INDICATORS

### Automatic Transmission

Sounds when you open the driver's door and do not move the transmission selector lever to position **P**.

### Key Outside Car

#### Vehicles With Keyless System

Sounds when you close the door, the engine is running and the system does not detect a passive key inside your vehicle.

### Headlamps On

Sounds when you remove the key from the ignition and open the driver's door and you have left the headlamps or parking lamps on.

# Instrument Cluster

---

## Low Fuel

Sounds when the low fuel warning lamp illuminates.

## Seat Belt Minder

### WARNINGS



The seat belt minder remains in stand-by mode when the front seat belts have been fastened. It will sound if either seat belt is unfastened.



Do not sit on top of a fastened seat belt to prevent the seat belt minder from coming on. The occupant protection system will only provide optimum protection when you use the seat belt properly.

---

Sounds when your vehicle speed exceeds the pre-determined limit and the front seat belts are unfastened. The chime will stop after a period of time.

# Information Displays

## GENERAL INFORMATION

### WARNING



Driving while distracted can result in loss of vehicle control, accident and injury. We strongly recommend that you use extreme caution when using any device or feature that may take your focus off the road. Your primary responsibility is the safe operation of your vehicle. We recommend against the use of any handheld device while driving and that you comply with all applicable laws.

**Note:** *The information display will remain on for several minutes after you switch the ignition off.*

Various systems on your vehicle can be controlled using the information display controls on your audio unit. Corresponding information is displayed in the information display.

### Device List

The icon changes to show the current function in use.



CD



Radio



Auxiliary input

## Information Display Controls



E103626

To use the controls:

- Press the up and down arrow buttons to scroll through and highlight the options within a menu.
- Press the right arrow button to enter a sub-menu.
- Press the left arrow button to exit a menu.
- Press and hold the left arrow button at any time to return to the main menu display (escape button).
- Press the **OK** button to choose and confirm settings or messages.

### Menu Structure - Information Display

#### All Vehicles

You can access the menu using the information display control.

**Note:** *Some options may appear slightly different or not at all if the items are optional.*

CD	
Tracks and folders	

# Information Displays

<b>Radio</b>	
FM	Stations
FM3-AST	Stations
AM	Stations
AM2-AST	Stations
DAB1	Stations
DAB2	Stations

SYNC-Media allows you to access the SYNC® features.

<b>SYNC-Phone</b>	
Dial number	
Redial	
Phonebook	
Call history	
Speed Dial	
Text messaging	
BT Devices	
Phone settings	

<b>Menu</b>	
SYNC<Settings	Bluetooth on
	Set defaults
	Master reset
	Install on SYNC
	System info
	Voice settings
SYNC-Apps	

## Information Displays

<b>Menu</b>	
Ford EcoMode	
Audio settings	Spd. Comp. Vol.
	Sound
	Occupancy Mode
	DSP Equaliser
	News
	Alt. Frequency
	Regional Mode
	DAB Servicelink
	Bluetooth
Vehicle settings	Traction control
	Active City Stop
	Deflation Detect
	Hill Start Assist
	Alarm
	Powerfold Mirrors
	Indicator
	Ambient Light
	Chimes
Clock Settings	Set Time
	Set Date
	24H Mode
Display Settings	Units of Measure
	Language
	Dimming
System Check	

# Information Displays

## System Check

All active warnings will display first if applicable. The system check menu may appear different based upon equipment options and current vehicle status. Use the up and down arrow buttons to scroll through the list.

## CLOCK

### Type 1

To adjust the clock, switch the ignition on and press buttons H or M on the information and entertainment display as necessary.

### Type 2

**Note:** Use the information display to adjust the clock. See **General Information** (page 58).

## TRIP COMPUTER



E102759

Press the button to scroll through the displays.

**Ø MPG** You can reset the trip, average fuel consumption and average speed. Scroll to the required display, then press and hold the button.

The trip computer includes the following information displays:

## Trip Odometer

**MLS  
TRIP**

Registers the distance travelled of individual journeys.

**KM  
TRIP**

## Distance to Empty



Indicates the approximate distance your vehicle will travel on the fuel remaining in the tank. Changes in driving pattern may cause the value to vary.

## Average Fuel Consumption

**Ø MPG**

Indicates the average fuel consumption since the function was last reset.

**Ø L  
100KM**

## Instantaneous Fuel Consumption

**MPG**

Indicates the current fuel consumption.

**L  
100KM**

## Stationary Fuel Consumption

**G  
H**

Indicates the current fuel consumption while stationary.

**L  
H**

## Average Speed

**Ø MPH**

Indicates the average speed calculated since the function was last reset.

**Ø KM  
H**

# Information Displays

## Distance Odometer

**MLS** Registers the total distance your vehicle has travelled.

**KM**

## PERSONALISED SETTINGS

### Measure Units

To toggle between imperial and metric units, scroll to this display and press the **OK** button.

Toggling the measure units using this display will affect the following displays:

- Distance to empty.
- Average fuel consumption.
- Instantaneous fuel consumption.
- Average speed.

### Switching Chimes Off

The following chimes can be switched off:

- Warning messages.
- Information messages.

## Airbag

Message	Message indicator	Action
Airbag malfunction Service now	amber	Have the system checked by an authorised dealer as soon as possible.

## INFORMATION MESSAGES

**Note:** Depending on the options on your vehicle, not all of the messages will display or be available. Certain messages may be abbreviated or shortened depending upon which cluster type you have.



E103626

Press the **OK** button to acknowledge and remove some messages from the information display. Other messages will be removed automatically after a short time.

Certain messages need to be confirmed before you can access the menus.

**i** The message indicator illuminates to supplement some messages. It will be red or amber depending on the severity of the message and will remain on until the cause of the message has been rectified.

Some messages will be supplemented by a system specific symbol with a message indicator.



# Information Displays

## Alarm

Message	Message indicator	Action
Alarm triggered Check vehicle	amber	See <b>Security</b> (page 35).
Interior scan deactivated	amber	See <b>Security</b> (page 35).
Alarm system malfunction Next service	-	Have the system checked by an authorised dealer.

## Doors Open

Message	Message indicator	Action
Driver door open	red	Vehicle is moving. Stop your vehicle as soon as safely possible and close.
Driver's rear door open	red	Vehicle is moving. Stop your vehicle as soon as safely possible and close.
Passenger door open	red	Vehicle is moving. Stop your vehicle as soon as safely possible and close.
Passenger rear door open	red	Vehicle is moving. Stop your vehicle as soon as safely possible and close.
Boot open	red	Vehicle is moving. Stop your vehicle as soon as safely possible and close.
Bonnet open	red	Vehicle is moving. Stop your vehicle as soon as safely possible and close. See <b>Opening and Closing the Bonnet</b> (page 134).
Driver door open	amber	Vehicle not moving. Close.
Driver's rear door open	amber	Vehicle not moving. Close.
Passenger door open	amber	Vehicle not moving. Close.

## Information Displays

Message	Message indicator	Action
Passenger rear door open	amber	Vehicle not moving. Close.
Boot open	amber	Vehicle not moving. Close.
Bonnet open	amber	Vehicle not moving. Close. See <b>Opening and Closing the Bonnet</b> (page 134).

### Engine

Message	Message indicator	Action
Engine preheating	amber	See <b>Starting a Diesel Engine</b> (page 86).

### Engine Immobiliser

Message	Message indicator	Action
Immobiliser malfunction Service now	red	Have the system checked by an authorised dealer as soon as possible.

### Keyless System

Message	Message indicator	Action
Key not detected	amber	See <b>Keyless Entry</b> (page 32).
Key outside car	amber	See <b>Keyless Entry</b> (page 32).
Key Battery low Replace battery	amber	See <b>Remote Control</b> (page 25).
Turn ignition off Use POWER button	amber	See <b>Keyless Starting</b> (page 83).
To start press brake	-	See <b>Keyless Starting</b> (page 83).

## Information Displays

Message	Message indicator	Action
To start press clutch	-	See <b>Keyless Starting</b> (page 83).
Close boot or use spare key	-	See <b>Keyless Entry</b> (page 32).
Steering lock engaged Turn steering wheel	-	See <b>Steering Wheel Lock</b> (page 85).

### Lighting

Message	Message indicator	Action
Left indicator malfunction Change bulb	-	See <b>Changing a Bulb</b> (page 143).
Right indicator malfunction Change bulb	-	See <b>Changing a Bulb</b> (page 143).

### Maintenance

Message	Message indicator	Action
Brake fluid Level low Service now	red	See <b>Brake and Clutch Fluid Check</b> (page 141).
Brake system malfunction Stop safely	red	Have the system checked by an authorised dealer immediately.
Engine oil pressure low Stop safely	red	See <b>Engine Oil Check</b> (page 139).
Engine malfunction Service now	amber	Have the system checked by an authorised dealer as soon as possible.
Auto wiper/lights malfunction Next service	amber	Have the system checked by an authorised dealer.
Engine oil change due Next service	-	Have the system checked by an authorised dealer.

## Information Displays

### Steering

Message	Message indicator	Action
Steering malfunction Service now	red	Have the system checked by an authorised dealer immediately.
Steering malfunction Stop safely	red	Have the system checked by an authorised dealer immediately.
Power steering malfunction Service now	amber	Full steering will be maintained but you will need to exert greater force on the steering wheel. Have the system checked by an authorised dealer as soon as possible.

### Transmission

Message	Message indicator	Action
Transmission malfunction Service now	red	Have the system checked by an authorised dealer immediately.
Transmission overtemp. Stop safely	red	Under certain driving conditions it is possible that the clutches in the transmission can overheat. In these circumstances it is necessary to press the brake pedal and stop your vehicle to prevent damage to the transmission. Move the transmission selector lever to position <b>N</b> or <b>P</b> and apply the parking brake until the transmission has cooled and the message disappears from the display.
Vehicle not in Park Select P	-	See <b>Automatic Transmission</b> (page 97). See <b>Starting and Stopping the Engine</b> (page 83).
To start select N or P	-	See <b>Automatic Transmission</b> (page 97). See <b>Starting and Stopping the Engine</b> (page 83).

## Information Displays

Message	Message indicator	Action
To start press brake	-	See <b>Starting and Stopping the Engine</b> (page 83).
To start select N	-	See <b>Automatic Transmission</b> (page 97). See <b>Starting and Stopping the Engine</b> (page 83).
Door open apply brake	-	See <b>Automatic Transmission</b> (page 97). See <b>Starting and Stopping the Engine</b> (page 83).

### Stability Control

Message	Message indicator	Action
ABS malfunction Service now	amber	Have the system checked by an authorised dealer as soon as possible.
ESP malfunction Next service	-	Have the system checked by an authorised dealer.
ESP off	-	See <b>Using Stability Control</b> (page 103).

### Tyre Pressure Monitoring System

Message	Message indicator	Action
Check Tyre pressures	amber	The pressure in one or more tyres has dropped. Check as soon as possible.
Tyre pressure sys malfunction service required	amber	Permanent malfunction. Have your vehicle checked by an authorised dealer.

# Climate Control

## PRINCIPLE OF OPERATION

### Outside Air

Keep the air intakes in front of the windscreen free from obstruction (snow, leaves etc.) to allow the climate control system to function effectively.

### Recirculated Air

#### WARNING



Prolonged use of recirculated air may cause the windows to mist up. If the windows mist up, follow the settings for demisting the windscreen.

The air currently in the passenger's compartment will be recirculated. Outside air will not enter your vehicle.

### Heating

Heating performance depends on the temperature of the engine coolant.

### Air Conditioning

**Note:** The air conditioning operates only when the temperature is above 39°F (4°C).

**Note:** If you use the air conditioning, the fuel consumption of your vehicle will be higher.

Air is directed through the evaporator where it is cooled. Humidity is extracted from the air to help keep the windows free of mist. The resulting condensation is directed to the outside of your vehicle and it is therefore normal if you see a small pool of water under your vehicle.

### General Information on Controlling the Interior Climate

Fully close all the windows.

### Warming the Interior

Direct the air toward your feet. In cold or humid weather conditions, direct some of the air toward the windscreen and the door windows.

### Cooling the Interior

Direct the air toward your face.

## AIR VENTS

### Centre Air Vents

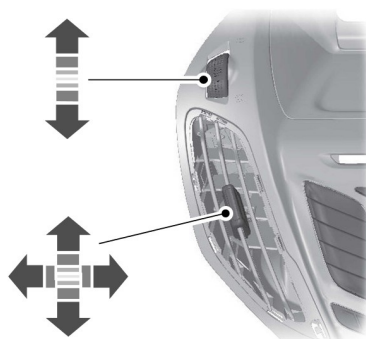

E142194

### Side Air Vent

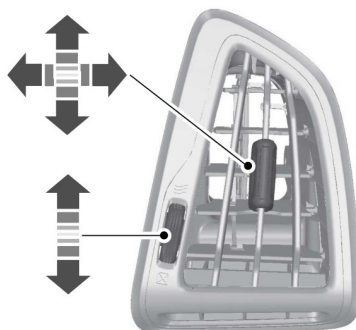

E142195

# Climate Control

## MANUAL CLIMATE CONTROL

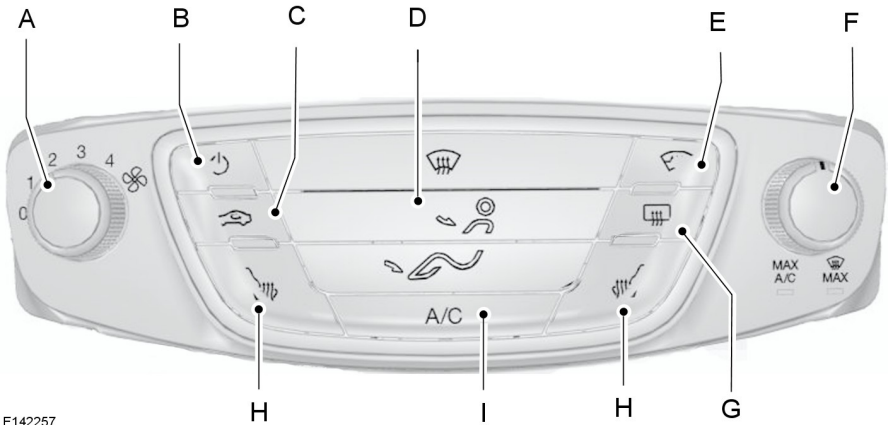

E142257

- A **Fan speed control:** Controls the volume of air circulated in your vehicle. Adjust to select the desired fan speed or switch off. If you switch the fan off, the windscreen may fog up.
- B **On and off:** Press the button to turn the system on and off. When the system is off, outside air is prevented from entering your vehicle.
- C **Recirculated air:** Press the button to switch between outside air and recirculated air. When you select recirculated air, the button illuminates and the air currently in the passenger compartment recirculates. This can reduce the time needed to cool the interior and reduce unwanted odours from entering your vehicle.
- D **Air distribution control:** Adjust to select the desired air distribution.
- E **Heated windscreen:** Press the button to defog and clear the windscreen of a thin covering of ice.
- F **Temperature control:** Controls the temperature of the air circulated in your vehicle. Adjust to select the desired temperature. If you select **MAX A/C**, the system distributes recirculated air through the instrument panel air vents. This mode is more economical and efficient than normal air conditioning.
- G **Heated rear window:** Press the button to defog and clear the rear window of a thin covering of ice.

# Climate Control

- H **Heated front seats:** Press the button to turn the heated seats on. See **Heated Seats** (page 80).
- I **Air conditioning:** Press the button to switch the air conditioning on or off. Air conditioning cools your vehicle using outside air. To improve air conditioning when starting your vehicle, drive with the windows slightly open for two to three minutes.

## AUTOMATIC CLIMATE CONTROL

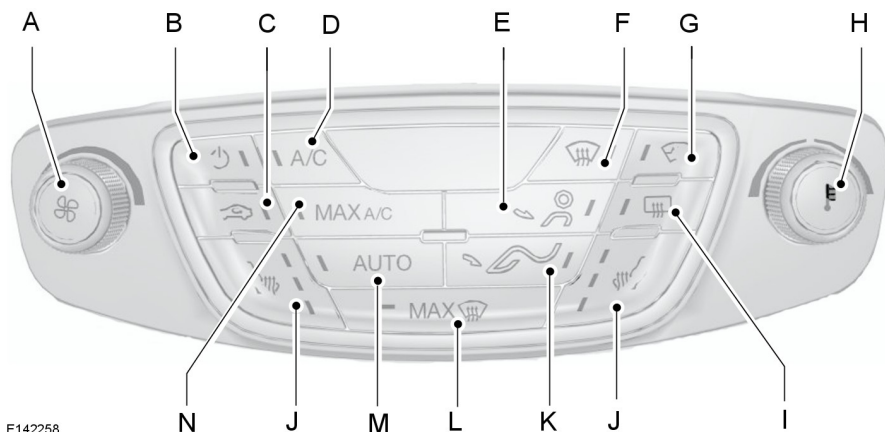

E142258

- A **Fan speed:** Controls the volume of air circulated in your vehicle. Rotate the control to select the desired fan speed. The setting is shown in the display.
- B **On and off button:** Press the button to switch the system on and off.
- C **Recirculated air:** Press the button to switch between outside air and recirculated air. The air currently in the passenger compartment recirculates. This can reduce the time needed to cool the interior and reduce unwanted odours from entering your vehicle.
- D **Air conditioning:** Press the button to switch the air conditioning on or off. Air conditioning cools your vehicle using outside air. To improve air conditioning when starting your vehicle, drive with the windows slightly open for two to three minutes.
- E **Instrument panel:** Press the button to distribute air through the instrument panel air vents.



# Climate Control

---

- F **Windscreen:** Press the button to distribute air through the windscreen air vents. You can also use this setting to defog and clear the windscreen of a thin covering of ice.
- G **Heated windscreen:** Press the button to defog and clear the windscreen of a thin covering of ice.
- H **Temperature control:** Controls the temperature of the air circulated in your vehicle. Adjust to select the desired temperature. If you select **MAX A/C**, the system distributes recirculated air through the instrument panel air vents. This mode is more economical and efficient than normal air conditioning.
- I **Heated rear window:** Press the button to defog and clear the rear window of a thin covering of ice.
- J **Heated front seats:** Press the button to turn the heated seats on. See **Heated Seats** (page 80).
- K **Footwell:** Press the button to distribute air through the footwell air vents.
- L **Windscreen defrosting and defogging:** Press the button to distribute outside air through the windscreen air vents. The heated windows and air conditioning will be automatically selected. The fan will be set to the highest speed and the temperature to high. When the air distribution is set in this position, you will be unable to select recirculated air or manually adjust the fan speed and temperature control. Press the **AUTO** button to return the system to auto mode.
- M **AUTO:** Press the button to select automatic operation. The system automatically controls the temperature, amount and distribution of the airflow to reach and maintain your previously selected temperature.
- E **MAX A/C:** Press the button to distribute maximum air conditioning through the instrument panel air vents. This mode is more economical and efficient than normal air conditioning.

# Climate Control

## Temperature Control



E142272

You can set the temperature between 61°F (16°C) and 82°F (28°C) in steps of 1°F (0.5°C). In position low, the system will switch to permanent cooling. In position high, the system will switch to permanent heating.

**Note:** If you select either position low or high, the system will not regulate a stable temperature.

## HINTS ON CONTROLLING THE INTERIOR CLIMATE

### General Hints

**Note:** Prolonged use of recirculated air may cause the windows to fog up.

**Note:** A small amount of air may be felt from the footwell air vents regardless of the air distribution setting.

**Note:** To reduce humidity build-up inside your vehicle, do not drive with the system switched off or with recirculated air always switched on.

**Note:** Do not place objects under the front seats as this may interfere with the airflow to the rear seats.

**Note:** Remove any snow, ice or leaves from the air intake area at the base of the windshield.

### Manual Climate Control

**Note:** To reduce fogging of the windshield during humid weather, adjust the air distribution control to the windshield air vents position. Increase the temperature and fan speed to improve clearing, if required.

### Automatic Climate Control

**Note:** Do not adjust the settings when your vehicle interior is extremely hot or cold. The system automatically adjusts to the previously stored settings. For the system to function efficiently, the instrument panel and side air vents should be fully open.

**Note:** At low ambient temperatures with **AUTO** selected, the air stream is directed toward the windshield and side windows for as long as the engine remains cold.

**Note:** When the system is switched off, outside air is prevented from entering your vehicle.

**Note:** When the system is in **AUTO** mode and the interior and exterior temperatures are high, the system automatically selects recirculated air to maximize cooling of the interior. When the selected air temperature is reached, the system automatically selects outside air.

**Note:** When you select windshield defrosting and defogging, the instrument panel and footwell level functions automatically switch off and air conditioning switches on. Outside air flows into your vehicle.

# Climate Control

## Heating the Interior Quickly

	Vehicles With Manual Climate Control	Vehicles With Automatic Climate Control
1	Adjust the fan speed to the highest speed setting.	Adjust the fan speed to the highest speed setting.
2	Adjust the temperature control to the highest setting.	Adjust the temperature control to the highest setting.
3	Adjust the air distribution control to the footwell air vents position.	Press the footwell button to distribute air to the footwell air vents.

## Recommended Settings for Heating

	Vehicles With Manual Climate Control	Vehicles With Automatic Climate Control
1	Adjust the fan speed to the second speed setting.	Press the <b>AUTO</b> button.
2	Adjust the temperature control to the midway point of the hot settings.	Adjust the temperature control setting to the desired setting.
3	Adjust the air distribution control to the footwell and windscreen air vents position.	Close the instrument panel air vents. Open the side air vents and direct them toward the side windows.

## Cooling the Interior Quickly

	Vehicles With Manual Climate Control	Vehicles With Automatic Climate Control
1	Adjust the fan speed to the highest speed setting.	Press the <b>AUTO</b> button.
2	Adjust the temperature control to the <b>MAX A/C</b> position.	Adjust the temperature control setting to low.
3	Adjust the air distribution control to the instrument panel air vents position.	

# Climate Control

## Recommended Settings for Cooling

	Vehicles With Manual Climate Control	Vehicles With Automatic Climate Control
1	Adjust the fan speed to the second speed setting.	Press the <b>AUTO</b> button.
2	Adjust the temperature control to the midway point of the cold settings.	Adjust the temperature control to the desired setting.
3	Adjust the air distribution control to the instrument panel air vents position.	Open all instrument panel air vents and direct as desired.

## Vehicle Stationary for Extended Periods During Extreme High Ambient Temperatures

	Vehicles With Manual Climate Control	Vehicles With Automatic Climate Control
1	Apply the parking brake.	Apply the parking brake.
2	Move the transmission selector lever to position <b>P</b> or neutral.	Move the transmission selector lever to position <b>P</b> or neutral.
3	Adjust the temperature control to the <b>MAX A/C</b> position.	Press the <b>MAX A/C</b> button.
4	Adjust the fan speed to the lowest speed setting.	

## Side Window Defogging in Cold Weather

	Vehicles With Manual Climate Control	Vehicles With Automatic Climate Control
1	Adjust the air distribution control to the instrument panel and footwell air vents positions.	Press the windscreen defrosting and defogging button.
2	Press the <b>A/C</b> button.	Adjust the temperature control to the desired setting.
3	Adjust the temperature control to the desired setting.	

# Climate Control

	Vehicles With Manual Climate Control	Vehicles With Automatic Climate Control
4	Adjust the fan speed to the highest setting.	
5	Direct the instrument panel side air vents toward the side windows.	
6	Close the instrument panel vents.	

## Maximum Cooling Performance in Instrument Panel or Instrument Panel and Footwell Positions

1. Adjust the temperature control to the lowest setting.
2. Press the **A/C** and recirculated air buttons.
3. Adjust the fan speed to the highest setting initially and then adjust it to suit the desired comfort level.

## HEATED WINDOWS AND MIRRORS

### Heated Windows

Use the heated windows to defrost or demist the windscreen or rear window.

**Note:** *The heated windows operate only when the engine is running.*

### Heated Windscreen



### Heated Rear Window



### Heated Exterior Mirrors

Electric exterior mirrors have a heating element that will defrost or demist the mirror glass. They will switch on automatically when you switch the heated rear window on.

# Seats

## SITTING IN THE CORRECT POSITION

### WARNINGS



Do not recline the seatback too far as this can cause the occupant to slide under the seat belt, resulting in serious injury in the event of a collision.



Sitting improperly, out of position or with the seatback reclined too far, can result in serious injury or death in the event of a collision. Always sit upright against your seatback, with your feet on the floor.



Do not place objects higher than the seatback to reduce the risk of serious injury in the event of a collision or during heavy braking.

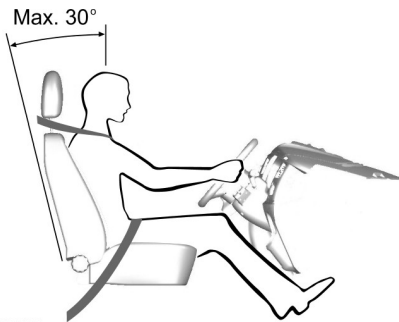

E68595

When you use them properly, the seat, head restraint, seat belt and airbags will provide optimum protection in the event of a collision.

We recommend that you follow these guidelines:

- Sit in an upright position with the base of your spine as far back as possible.
- Do not recline the seatback more than 30 degrees.

- Adjust the head restraint so that the top of it is level with the top of your head and as far forward as possible. Make sure that you remain comfortable.
- Keep sufficient distance between yourself and the steering wheel. We recommend a minimum of 10 inches (25 centimetres) between your breastbone and the airbag cover.
- Hold the steering wheel with your arms slightly bent.
- Bend your legs slightly so that you can press the pedals fully.
- Position the shoulder strap of the seat belt over the centre of your shoulder and position the lap strap tightly across your hips.

Make sure that your driving position is comfortable and that you can maintain full control of your vehicle.

## HEAD RESTRAINTS

### WARNING



Fully adjust the head restraint before you sit in or operate your vehicle. This will help minimise the risk of neck injury in the event of a collision. Do not adjust the head restraint when your vehicle is moving.

## Adjusting the Head Restraints

Adjust the head restraint so that the top of it is level with the top of your head.

# Seats

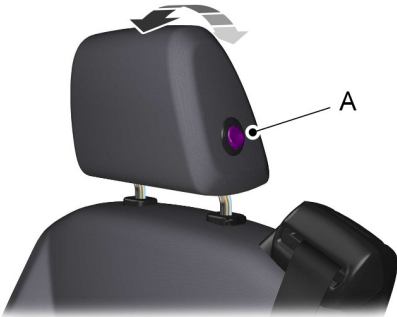

E142196

1. Press button A to move the restraint rearward.
2. To move the restraint forward pull the headrest.

## Removing the Head Restraint

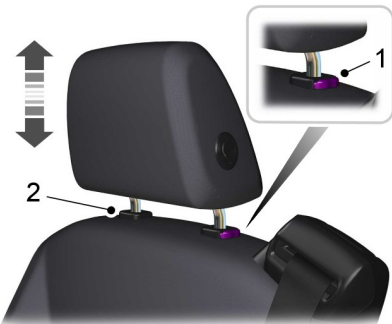

E142144

1. Press and hold the locking button.
2. Using a suitable implement release the retaining clip.

## Rear Outer Head Restraint

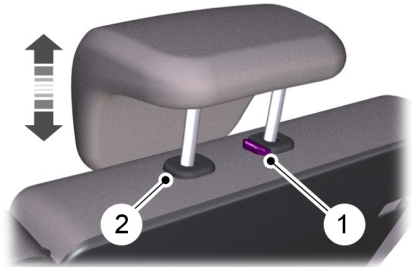

E140448

1. Press and hold the locking button.
2. Using a suitable implement release the retaining clip.

## Rear Centre Head Restraint

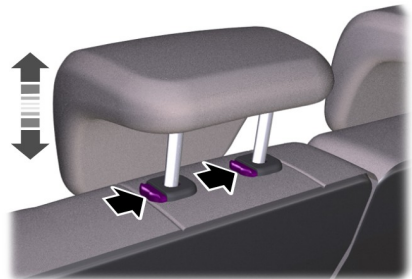

E135401

Press the locking buttons and remove the head restraint.

# Seats

## MANUAL SEATS

### WARNINGS

 Do not place cargo or any objects behind the seatback before returning it to the original position. Pull on the seatback to make sure that it has fully latched after returning the seatback to its original position. An unlatched seat may become dangerous if you stop suddenly or have a collision.

 Rock the seat backward and forward after releasing the lever to make sure that it is fully engaged in its catch.

### Moving the Seat Backward and Forward



### Adjusting the Lumbar Support



### Adjusting the Height of the Driver's Seat





# Seats



## Recline Adjustment



E142200

## Folding the Passenger's Seat Forward

### WARNINGS

-  Do not drive with the passenger's seat folded forwards if the rear or centre seat behind is occupied.
-  Do not fold with items on the folded seatback.
-  When folding the passenger's seat forward, make sure that you keep clear of the seatback and seat frame.

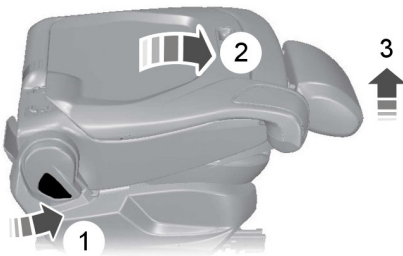

E142940



1. Push the locking lever

2. Fold the seat forward. Make sure that the seatback is in the folded position and securely latched.
3. Push the locking lever to return the seatback to the vertical position. Make sure that the seatback is securely latched in position.

## REAR SEATS

### Folding the Seatback

#### WARNINGS

-  When folding the seatbacks down, take care not to get your fingers caught between the seatback and seat frame.
-  Do not attempt to fold the rear seat cushion forward.
-  Lower the head restraints. See **Head Restraints** (page 76).



E86611

1. Press the unlock buttons down and hold them there.
2. Push the seatback forward. As the rear seatback lowers the seat cushion will also lower.

# Seats

## Unfolding the Seatback

### WARNINGS



When folding the seatbacks up, make sure that the belts are visible to an occupant and not caught behind the seat.



Make sure that the seats and the seatbacks are secure and fully engaged in their catches.



## HEATED SEATS

### WARNING



People who are unable to feel pain to their skin because of advanced age, chronic illness, diabetes, spinal cord injury, medication, alcohol use, exhaustion or other physical conditions, must exercise care when using the heated seat. The heated seat may cause burns even at low temperatures, especially if used for long periods of time. Do not place anything on the seat that insulates against heat, such as a blanket or cushion. This may cause the heated seat to overheat. Do not puncture the seat with pins, needles or other pointed objects. This may damage the heating element which may cause the heated seat to overheat. An overheated seat may cause serious personal injury.

Do not do the following:

- Place heavy objects on the seat.
- Operate the heated seat if water or any other liquid is spilled on the seat. Allow the seat to dry thoroughly.
- Operate the heated seats unless the engine is running. Doing so could drain your vehicle battery.

For item location: See **Climate Control** (page 68).

The heated seat will only operate with the ignition switched on.

The maximum temperature is reached after five or six minutes. It is regulated thermostatically.

The heated seat will remain on until either the heated seat switch or the ignition is switched off.

## FRONT SEAT ARMREST

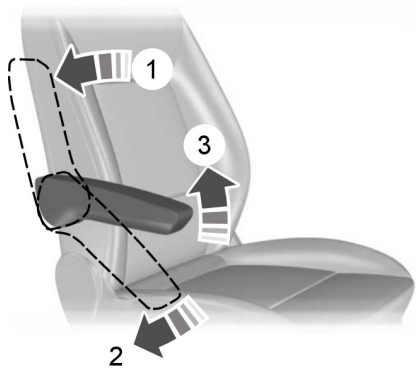

E95256

# Auxiliary Power Points

**Note:** When you switch the ignition on, you can use the socket to power 12 volt appliances with a maximum current rating of 20 amps.

After you switch the ignition off the power supply will only work for a maximum of 30 minutes.

**Note:** Do not insert objects other than an accessory plug into the power point. This will damage the outlet and blow the fuse.

**Note:** Do not hang any type of accessory or accessory bracket from the plug.

**Note:** Do not use the power point for operating a cigar lighter element.

**Note:** Incorrect use of the power point can cause damage not covered by your warranty.

**Note:** Always keep the power point caps closed when not in use.

Run the engine for full capacity use of the power point. To prevent the battery from losing charge:

- Do not use the power point longer than necessary when the engine is not running.
- Do not leave devices plugged in overnight or when the vehicle is parked for extended periods.

## Location

Power points may be found:

- on the rear of the centre console
- on the centre console.

## CIGAR LIGHTER

**Note:** Do not hold the cigar lighter element pressed in.

**Note:** If you use the socket when the engine is not running, the battery may lose charge.

**Note:** When you switch the ignition on, you can use the socket to power 12 volt appliances with a maximum current rating of 20 amps.

**Note:** After you switch the ignition off the power supply will only work for a maximum of 30 minutes.

**Note:** Use only Ford accessory connectors or connectors specified for use with SAE standard sockets.

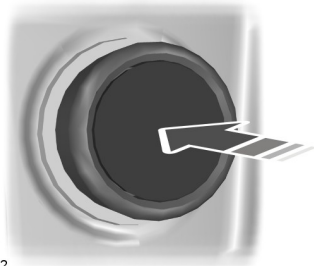

E103382

Press the element in to use the cigar lighter. It will pop out automatically.

# Storage Compartments

---

## CUP HOLDERS

### WARNING



Do not place hot drinks in the cup holders when your vehicle is moving.

## GLASSES HOLDER

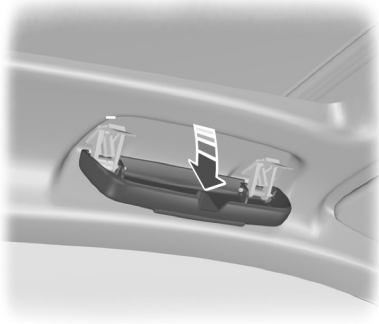

E91508

# Starting and Stopping the Engine

## GENERAL INFORMATION

If you disconnect the battery, your vehicle may exhibit some unusual driving characteristics for approximately 5 miles (8 kilometres) after you reconnect it. This is because the engine management system must realign itself with the engine. You can disregard any unusual driving characteristics during this period.

### WARNINGS

 Extended idling at high engine speeds can produce very high temperatures in the engine and exhaust system, creating the risk of fire or other damage.

 Do not park, idle or drive your vehicle on dry grass or other dry ground cover. The emission system heats up the engine compartment and exhaust system, creating the risk of fire.

 Do not start the engine in a closed garage or in other enclosed areas. Exhaust fumes can be toxic. Always open the garage door before you start the engine.

 If you smell exhaust fumes inside your vehicle, have your vehicle checked by your authorised dealer immediately. Do not drive your vehicle if you smell exhaust fumes.

The powertrain control system meets all Canadian interference-causing equipment standard requirements regulating the impulse electrical field or radio noise.

When you start the engine, avoid pressing the accelerator pedal before and during operation. Only use the accelerator pedal when you have difficulty starting the engine.

## IGNITION SWITCH



E72128

**O** (off) - The ignition is off.

**Note:** *When you switch the ignition off and leave your vehicle, do not leave your key in the ignition. This could cause your vehicle battery to lose charge.*

**I** (accessory) - Allows the electrical accessories such as the radio to operate while the engine is not running.

**Note:** *Do not leave the ignition key in this position for too long to avoid your vehicle battery losing charge.*

**II** (on) - All electrical circuits operational. Warning lamps and indicators are illuminated.

**III** (start) - cranks the engine. Release the key as soon as the engine starts.

## KEYLESS STARTING

### WARNINGS

 The system may not function if the key is close to metal objects or electronic devices such as mobile phones.

 Always check that the steering wheel lock is deactivated before attempting to move your vehicle.

**Note:** *The ignition will automatically switch off when you leave your vehicle unattended. This is to prevent your vehicle battery running out of charge.*

# Starting and Stopping the Engine

**Note:** A valid key must be located inside your vehicle to switch the ignition on and start the engine.

## Ignition On

Press the START button once. It is located on the instrument panel near the steering wheel. All electrical circuits and accessories are operational and the warning lamps and indicators will illuminate.



E142318

## Starting With Manual Transmission

**Note:** Releasing the clutch pedal while the engine is starting will stop the engine cranking and return to ignition on.

1. Fully depress the clutch pedal.
2. Briefly press the button.

## Starting With Automatic Transmission

**Note:** Releasing the brake pedal while the engine is starting will stop the engine cranking and return to ignition on.

1. Move the transmission selector lever to position P or N.
2. Fully depress the brake pedal.
3. Briefly press the button.

## Starting a Diesel Engine

**Note:** Engine cranking will not commence until the engine glow plug indicator has extinguished. This may take several seconds in extremely cold conditions.

## Failure to Start

### All Vehicles

The system will not function if:

- The key frequencies are jammed.
- The key battery has no charge.

If you are unable to start your vehicle, do the following.

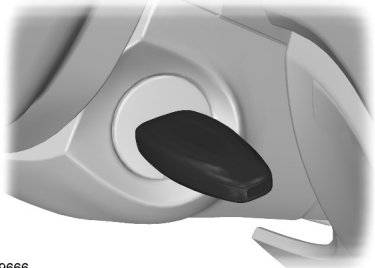

E99666

1. Hold the key next to the steering column exactly as shown.
2. With the key in this position you can use the button to switch the ignition on and start your engine.

## Manual Transmission

**Note:** Releasing the clutch pedal while the engine is starting will stop the engine cranking and return to ignition on. A message will be shown in the display.

If the engine does not crank when the clutch pedal has been fully depressed and the button is pressed:

1. Fully depress both the clutch and brake pedals.
2. Press the button until the engine starts.

# Starting and Stopping the Engine

---

## Stopping the Engine With Your Vehicle Stationary

**Note:** *The ignition, all electrical circuits warning lamps and indicators will be switched off.*

### Manual Transmission

Briefly press the button.

### Automatic Transmission

1. Move the transmission selector lever to position P.
2. Press the button.

## Stopping the Engine When Your Vehicle is Moving

### WARNING



Switching off the engine when the vehicle is still moving will result in a loss of brake and steering assistance. The steering will not lock, but higher effort will be required. With the ignition switched off some electrical circuits, warning lamps and indicators may also be off.

---

1. Press and hold the button for at least one second or press it three times within two seconds.
2. Move the transmission selector lever to position N and use the brakes to bring your vehicle to a safe stop.
3. When your vehicle has stopped, move the transmission selector lever to position P or N and switch the ignition off.

## STEERING WHEEL LOCK

### WARNING



Always check that the steering is unlocked before attempting to move your vehicle.

---

## Vehicles Without Keyless Starting

To lock the steering wheel:

1. Remove the key from the ignition switch.
2. Rotate the steering wheel slightly to engage the lock.

## Vehicles With Keyless Starting

**Note:** *The steering wheel lock will not engage when the ignition is on or your vehicle is moving.*

Your vehicle has an electronically controlled steering wheel lock. This operates automatically.

The steering wheel lock will engage after a short period of time once you have parked your vehicle and the passive key is outside of your vehicle.

## Unlocking the Steering Wheel

### Vehicles With Automatic Transmission

Switch the ignition on or press the brake pedal.

### Vehicles With Manual Transmission

Switch the ignition on or press the clutch pedal.

## STARTING A PETROL ENGINE

**Note:** *You can only operate the starter for a limited period of time, for example 10 seconds. The number of start attempts is limited to approximately six. If you exceed this limit, the system will not allow you to try again until a period of time has elapsed, for example 30 minutes.*

## Cold or Hot Engine

### Vehicles with Manual Transmission

**Note:** *Do not touch the accelerator pedal.*

# Starting and Stopping the Engine

---

**Note:** Releasing the clutch pedal while the engine is starting will stop the engine cranking and return to ignition on.

1. Fully depress the clutch pedal.
2. Start the engine.

## Vehicles with Automatic Transmission

**Note:** Do not touch the accelerator pedal.

1. Move the transmission selector lever to position **P** or **N**.
2. Start the engine.

## All Vehicles

If the engine does not start within 10 seconds, wait for a short period and try again.

If the engine does not start after three attempts, wait 10 seconds and follow the flooded engine procedure.

If you have difficulty starting the engine when the temperature is below  $-13^{\circ}\text{F}$  ( $-25^{\circ}\text{C}$ ), press the accelerator pedal to the mid-way point of its travel and try again.

## Flooded Engine

### Vehicles with Manual Transmission

1. Fully depress the clutch pedal.
2. Fully depress the accelerator pedal and hold it there.
3. Start the engine.

### Vehicles with Automatic Transmission

1. Move the transmission selector lever to position **P** or **N**.
2. Fully depress the accelerator pedal and hold it there.
3. Start the engine.

## All Vehicles

If the engine does not start, repeat the cold or hot engine procedure.

## Engine Idle Speed after Starting

The speed at which the engine idles immediately after starting is optimised to minimise vehicle emissions and maximise cabin comfort and fuel economy.

The idle speed will vary depending on certain factors. These include vehicle component and ambient temperatures as well as electrical and climate system demands.

## Failure to Start

### Vehicles with Manual Transmission

If the engine does not crank when the clutch pedal has been fully depressed and the ignition key is turned to position III.

1. Fully depress the clutch and brake pedals.
2. Turn the key to position III until the engine has started.

# STARTING A DIESEL ENGINE

## Cold or Hot Engine

### All Vehicles

**Note:** When the temperature is below  $5^{\circ}\text{F}$  ( $-15^{\circ}\text{C}$ ), you may need to crank the engine for up to 10 seconds.

**Note:** You can only operate the starter for a limited period of time.

**Note:** After a limited number of attempts to start your engine, the system will not allow you to try again until a period of time has elapsed, for example 30 minutes.



Switch the ignition on and wait until the glow plug indicator goes off.

### Vehicles With Manual Transmission

**Note:** Do not touch the accelerator pedal.



# Starting and Stopping the Engine

---

**Note:** Releasing the clutch pedal while the engine is starting will stop the engine cranking and return to ignition on.

1. Fully depress the clutch pedal.
2. Start the engine.

## Vehicles With Automatic Transmission

**Note:** Do not touch the accelerator pedal.

**Note:** Releasing the brake pedal while the engine is starting will stop the engine cranking and return to ignition on.

1. Move the transmission selector lever to position **P** or **N**.
2. Fully depress the brake pedal.
3. Start the engine.

## Failure to Start

### Vehicles With Manual Transmission

If the engine does not crank when the clutch pedal has been fully depressed and the ignition key is turned to position **III**.

1. Fully depress the clutch and brake pedals.
2. Turn the key to position **III** until the engine has started.

## DIESEL PARTICULATE FILTER

The filter forms part of the emissions reduction system on your vehicle. It filters harmful diesel particulates (soot) from the exhaust gas.

## Regeneration

### WARNINGS



Do not park or idle your vehicle over dry leaves, dry grass or other combustible materials. The

regeneration process creates very high exhaust gas temperatures and the exhaust will radiate a considerable amount of heat during and after regeneration and after you have switched the engine off. This is a potential fire hazard.



Avoid running out of fuel.

**Note:** During regeneration at low speed or engine idle, you may smell a hot metallic odour and could notice a clicking metallic sound. This is due to the high temperatures reached during regeneration and is normal.

**Note:** After you have switched your engine off the fans may continue to run for a short period of time.

A normal filter requires periodic replacement. The diesel particulate filter on your vehicle requires periodic regeneration to maintain its correct function. Your vehicle will carry out this process automatically.

If your journeys meet one of the following conditions:

- You drive only short distances.
- You frequently switch the ignition on and off.
- Your journeys contain a high level of acceleration and deceleration.

# Starting and Stopping the Engine

---

You must carry out occasional trips with the following conditions to assist the regeneration process:

- Drive your vehicle in more favourable conditions, which you will find at higher vehicle speeds in normal driving, on a main road or motorway for a minimum of 20 minutes. This drive may include short stops that will not affect the regeneration process.
- Avoid prolonged idling and always observe speed limits and road conditions.
- Do not switch the ignition off.
- Select a suitable gear to ideally maintain engine speed between 1500 and 3000 RPM.

## SWITCHING OFF THE ENGINE

### Vehicles With a Turbocharger

#### WARNING



Do not switch the engine off when it is running at high speed. If you do, the turbocharger will continue running after the engine oil pressure has dropped to zero. This will lead to premature turbocharger bearing wear.

---

Release the accelerator pedal. Wait until the engine has reached idle speed and then switch it off.

# Unique Driving Characteristics

## START-STOP

**Note:** For vehicles with start-stop the battery requirement is different. It must be replaced by one of exactly the same specification as the original.

The system reduces fuel consumption and CO<sub>2</sub> emissions by shutting down the engine when your vehicle is idling, for example at traffic lights. The engine will automatically restart when you press the clutch pedal or when required by a vehicle system, for example to recharge the battery.

To obtain maximum benefit from the system, move the transmission selector lever to neutral and release the clutch pedal during any stop of longer than three seconds.

## Using Start-Stop

### WARNINGS



The engine may restart automatically if required by the system.



Switch the ignition off before opening the bonnet or carrying out any maintenance.



Always switch the ignition off before leaving your vehicle, as the system may have shut down the engine but the ignition will still be live.

**Note:** The system only operates when the engine is warm and the outside temperature is between 32°F (0°C) and 86°F (30°C).

**Note:** If you stall the engine, and then depress the clutch pedal within a short period of time, the system will automatically restart the engine.

**Note:** The start-stop indicator will illuminate green when the engine shuts down. See **Warning Lamps and Indicators** (page 53).

**Note:** When the start-stop indicator flashes amber, move the transmission selector lever to neutral or depress the clutch pedal.

**Note:** If the system detects a malfunction, it will switch off. Have the system checked by an authorised dealer.

**Note:** When you switch the system off, the switch will illuminate.

**Note:** The system automatically turns on every time you switch the ignition on. To switch the system off, press the switch in the instrument panel. The system will only be switched off for the current ignition cycle. To turn it on, press the switch again. For item location See **At a Glance** (page 8).



## To Stop the Engine

1. Stop your vehicle.
2. Move the transmission selector lever to neutral.
3. Release the clutch pedal.
4. Release the accelerator pedal.

The system may not shut down the engine under certain conditions, for example:

- To maintain the interior climate.
- Low battery voltage.
- The outside temperature is too low or too high.
- The driver's door has been opened.
- Low engine operating temperature.
- Low brake system vacuum.
- If a road speed of 3 mph (5 km/h) has not been exceeded.
- The driver's seat belt has not been fastened.

# Unique Driving Characteristics

---

## To Re-Start the Engine

**Note:** *The transmission selector lever must be in neutral.*

Depress the clutch pedal.

The system may automatically restart the engine under certain conditions, for example:

- Low battery voltage.
- To maintain the interior climate.

# Fuel and Refuelling

## SAFETY PRECAUTIONS

### WARNINGS



Do not overfill the fuel tank. The pressure in an overfilled tank may cause leakage and lead to fuel spray and fire.



The fuel system may be under pressure. If you hear a hissing sound near the fuel filler door (Easy Fuel capless fuel system), do not refuel until the sound stops. Otherwise, fuel may spray out, which could cause serious personal injury.



Automotive fuels can cause serious injury or death if misused or mishandled.



The flow of fuel through a fuel pump nozzle can produce static electricity, which can cause a fire if fuel is pumped into an ungrounded fuel container.



Fuel ethanol and petrol may contain benzene, which is a cancer-causing agent.



When refuelling always shut the engine off and never allow sparks or open flames near the filler neck. Never smoke while refuelling. Fuel vapour is extremely hazardous under certain conditions. Care should be taken to avoid inhaling excess fumes.

Observe the following guidelines when handling automotive fuel:

- Extinguish all smoking materials and any open flames before refuelling your vehicle.
- Always turn off the vehicle before refuelling.
- Automotive fuels can be harmful or fatal if swallowed. Fuel such as petrol is highly toxic and if swallowed can cause death or permanent injury. If fuel is swallowed, call a doctor immediately, even if no symptoms are immediately apparent. The toxic effects of fuel may not be visible for hours.
- Avoid inhaling fuel vapours. Inhaling too much fuel vapour of any kind can lead to eye and respiratory tract irritation. In severe cases, excessive or prolonged breathing of fuel vapour can cause serious illness and permanent injury.
- Avoid getting fuel liquid in your eyes. If fuel is splashed in the eyes, remove contact lenses (if worn), flush with water for 15 minutes and seek medical attention. Failure to seek proper medical attention could lead to permanent injury.
- Fuels can also be harmful if absorbed through the skin. If fuel is splashed on the skin, clothing or both, promptly remove contaminated clothing and wash skin thoroughly with soap and water. Repeated or prolonged skin contact with fuel liquid or vapour causes skin irritation.
- Be particularly careful if you are taking "Antabuse" or other forms of disulfiram for the treatment of alcoholism. Breathing petrol vapours, or skin contact could cause an adverse reaction. In sensitive individuals, serious personal injury or sickness may result. If fuel is splashed on the skin, promptly wash skin thoroughly with soap and water. Consult a doctor immediately if you experience an adverse reaction.

# Fuel and Refuelling

## FUEL QUALITY - PETROL

### WARNINGS



Do not mix petrol with oil, diesel or other liquids. This could cause a chemical reaction.



Do not use leaded petrol or petrol with additives containing other metallic compounds (e.g. manganese-based). They could damage the emission system.

**Note:** We recommend that you use only high quality fuel.

**Note:** We do not recommend the use of additional additives or other engine treatments for normal vehicle use.

Use minimum 95 octane unleaded petrol that meets the specification defined by EN 228 or the equivalent national specification.

Your vehicle is suitable for use with ethanol blends up to 10% (E5 and E10).

### Long-Term Storage

Most petrol contains ethanol. We recommend that you fill the fuel tank with fuel that does not contain ethanol if you intend to store your vehicle for more than two months. Alternatively, we recommend that you seek advice from your dealer.

## FUEL QUALITY - DIESEL

### WARNINGS



Do not mix diesel with oil, petrol or other liquids. This could cause a chemical reaction.



Do not add kerosene, paraffin or petrol to diesel. This could cause damage to the fuel system.

### WARNINGS



Use diesel that meets the specification defined by EN 590 or the relevant national specification.

**Note:** We recommend that you use only high quality fuel.

**Note:** We do not recommend the use of additional additives or other engine treatments for normal vehicle use.

**Note:** We do not recommend the use of additional additives to prevent fuel waxing.

### Long-Term Storage

Most diesel fuels contain biodiesel. We recommend that you fill the fuel tank with fuel that does not contain biodiesel if you intend to store your vehicle for more than two months. Alternatively, we recommend that you seek advice from your dealer.

## RUNNING OUT OF FUEL

Avoid running out of fuel because this situation may have an adverse effect on powertrain components.

If you have run out of fuel:

- You may need to cycle the ignition from off to on several times after refuelling to allow the fuel system to pump the fuel from the tank to the engine. On restarting, cranking time will take a few seconds longer than normal. With keyless ignition, just start the engine. Crank time will be longer than usual.
- Normally, adding 1 gallon (4.6 litres) of fuel is enough to restart the engine. If your vehicle is out of fuel and on a steep slope, more than 1 gallon (4.6 litres) may be required.

# Fuel and Refuelling

## Refilling With a Portable Fuel Container

### WARNINGS

 Do not insert the nozzle of portable fuel containers or aftermarket funnels into the capless fuel system. This could damage the fuel system and its seal, and may cause fuel to run onto the ground instead of filling the tank, which could result in serious personal injury.

 Do not try to pry open or push open the capless fuel system with foreign objects. This could damage the fuel system and its seal and cause injury to you or others.

**Note:** *Do not use aftermarket funnels; they will not work with the capless fuel system and can damage it. The included funnel has been specially designed to work safely with your vehicle.*

When filling your vehicle's fuel tank from a portable fuel container, use the funnel included with your vehicle.



E142668

1. Locate the plastic funnel in the glove box.
2. Slowly insert the funnel into the capless fuel system.
3. Fill your vehicle with fuel from the portable fuel container.

4. When done, clean the funnel or properly dispose of it. Extra funnels can be purchased from your authorised dealer if you choose to dispose of the funnel.





## CATALYTIC CONVERTER

### WARNING

 Do not park or idle your vehicle over dry leaves, dry grass or other combustible materials. The exhaust will radiate a considerable amount of heat during use, and after you have switched the engine off. This is a potential fire hazard.

## Driving with a Catalytic Converter

### WARNINGS

-  Avoid running out of fuel.
-  Do not crank the engine for long periods.
-  Do not run the engine when a spark plug lead is disconnected.
-  Do not push-start or tow-start your vehicle. Use booster cables. See **Jump-Starting the Vehicle** (page 122).
-  Do not switch the ignition off when driving.

## REFUELLING

### WARNINGS

 Do not attempt to start the engine if you have filled the fuel tank with the incorrect fuel. This could damage the engine. Have the system checked by an authorised dealer immediately.

# Fuel and Refuelling

## WARNINGS

 Do not use any kind of flames or heat near the fuel system. The fuel system is under pressure. There is a risk of injury if the fuel system is leaking.

 If you use a high pressure spray to wash your vehicle, only spray the fuel filler flap briefly from a distance not less than 8 inches (200 millimetres).

 We recommend that you wait at least 10 seconds before removing the fuel pipe nozzle to allow any residual fuel to drain into the fuel tank.

 Stop refuelling after the fuel nozzle stops the second time. Additional fuel will fill the expansion space in the fuel tank which could lead to fuel overflowing. Fuel spillage could be hazardous to other road users.

 Do not remove the nozzle from its fully inserted position during the entire refuelling process.

**Note:** It is not possible to fully open the sliding door when the fuel filler flap is open.

**Note:** Your vehicle does not have a fuel filler cap.

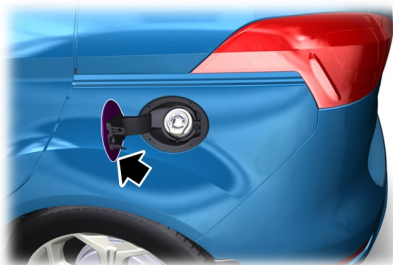

E153586

1. Press the flap to open it. Open the flap fully until it engages.

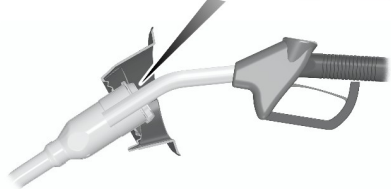
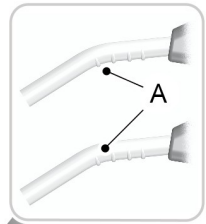

E139202

**Note:** When you insert the correct size fuel nozzle, a spring loaded inhibitor will open. This helps to avoid filling up with the wrong fuel.

2. Insert the fuel nozzle up to and including the first notch on the nozzle A. Keep it resting on the cover of the fuel pipe opening.

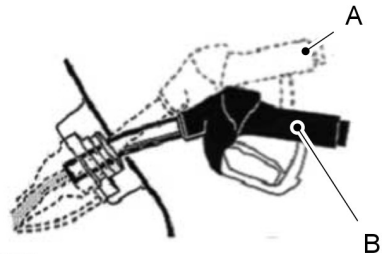

E139203

3. Hold the nozzle in position B during refuelling. Holding the nozzle in position A may affect the flow of fuel and shut off the fuel nozzle before the fuel tank is full.



# Fuel and Refuelling

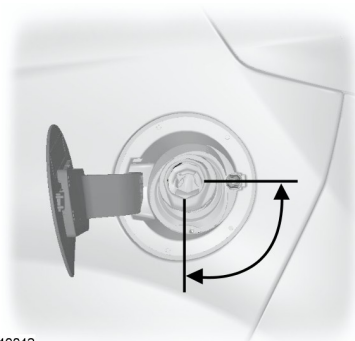

E140042

4. Operate the nozzle within the area shown.

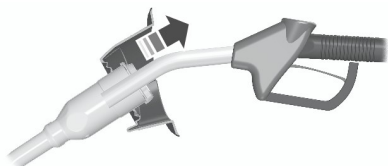

E119081

5. Slightly raise the fuel nozzle to remove it.

## FUEL CONSUMPTION

**Note:** *The amount of usable fuel in the empty reserve varies and should not be relied upon to increase driving range. When refuelling your vehicle after the fuel gauge indicates empty, you might not be able to refuel the full amount of the advertised capacity of the fuel tank due to the empty reserve still present in the tank.*

The CO<sub>2</sub> and fuel consumption figures are derived from laboratory tests according to Regulation (EC) 715/2007 and subsequent amendments are carried out by all vehicle manufacturers.

They are intended as a comparison between makes and models of vehicles. They are not intended to represent the real world fuel consumption you may get from your vehicle. Real world fuel consumption is governed by many factors including: driving style, high speed driving, stop-start driving, air conditioning usage, the accessories fitted, payload, towing, etc.

The advertised capacity is the indicated capacity and the empty reserve combined. Indicated capacity is the difference in the amount of fuel in a full tank and a tank when the fuel gauge indicates empty. Empty reserve is the amount of fuel in the tank after the fuel gauge indicates empty.

## Filling the Tank

For consistent results when filling the fuel tank:

- Switch the ignition off before fuelling. An inaccurate reading results if you leave the engine running.
- Use the same fill rate (low-medium-high) each time the tank is filled.
- Allow no more than two automatic shut-offs when filling.

Results are most accurate when the filling method is consistent.

## Calculating Fuel Economy

Do not measure fuel economy during the first 1000 miles (1600 km) of driving (this is your engine's running-in period). A more accurate measurement is obtained after 2000 - 3000 miles (3200 - 4800 km). Also, fuel expense, frequency of fill ups or fuel gauge readings are not accurate ways to measure fuel economy.

1. Fill the fuel tank completely and record the initial odometer reading.
2. Each time you fill the tank, record the amount of fuel added.

## Fuel and Refuelling

3. After at least three to five tank fill ups, fill the fuel tank and record the current odometer reading.
  4. Subtract your initial odometer reading from the current odometer reading.
  5. Calculate fuel economy by dividing miles travelled by gallons used (For Metric: Multiply litres used by 100, then divide by kilometres travelled).
- Keep a record for at least one month and record the type of driving (city or motorway). This provides an accurate estimate of your vehicle's fuel economy under current driving conditions. Additionally, keeping records during summer and winter show how temperature impacts fuel economy. In general, lower temperatures mean lower fuel economy.

## TECHNICAL SPECIFICATIONS

### Fuel Consumption Figures

Variant	Urban	Extra-Urban	Combined	CO2 Emissions
	l/100 km (mpg)	l/100 km (mpg)	l/100 km (mpg)	g/km
1.0L EcoBoost (74kW/100PS) without start-stop	6.6 (42.8)	4.3 (65.7)	5.1 (55.4)	119
1.0L EcoBoost (74kW/100PS) with start-stop	6 (47.1)	4.2 (67.3)	4.9 (57.6)	114
1.0L EcoBoost (90kW/120PS)	6 (47.1)	4.2 (67.3)	4.9 (57.6)	114
1.4L Duratec-16V	7.9 (35.8)	4.9 (57.6)	6 (47.1)	139
1.6L Duratec-16V Ti-VCT	8.6 (32.8)	5.1 (55.4)	6.4 (44.1)	149
1.5L Duratorq-TDCi	4.7 (60.1)	3.6 (78.4)	4 (70.6)	104
1.6L Duratorq-TDCi	4.8 (58.9)	3.8 (74.3)	4.1 (68.9)	109

# Transmission

## MANUAL TRANSMISSION

### Selecting Reverse Gear

Do not engage reverse gear when your vehicle is moving. This can cause damage to the transmission.

## AUTOMATIC TRANSMISSION

### WARNING

 Always set the parking brake fully and make sure you move the transmission selector lever to position **P**. Switch the ignition off and remove the key whenever you leave your vehicle.

### Selector Lever Positions



E133124

- P Park
- R Reverse
- N Neutral
- D Drive
- S Sport mode and manual shifting
- + Manual shift up
- Manual shift down

### WARNING

 Apply the brakes before moving the transmission selector lever and keep them applied until you are ready to move off.

Press the button on the transmission selector lever to change to each position.

The transmission selector lever position will be shown in the information display.

### P (Park)

#### WARNINGS

 Move the transmission selector lever to park only when your vehicle is stationary.

 Apply the parking brake and move the transmission selector lever to park before leaving your vehicle.

Make sure that the transmission selector lever is latched in position.

**Note:** *An audible warning will sound if you open the driver's door and you have not moved the transmission selector lever to park.*

In this position, power is not transmitted to the drive wheels and the transmission is locked. You can start the engine with the transmission selector lever in this position.

### R (Reverse)

#### WARNINGS

 Move the transmission selector lever to reverse only when your vehicle is stationary and the engine is at idle speed.

 Always come to a complete stop before shifting the transmission selector lever out of reverse.

# Transmission

Move the transmission selector lever to reverse to allow your vehicle to move backward.

## N (Neutral)

In this position, power is not transmitted to the drive wheels but the transmission is not locked. You can start the engine with the transmission selector lever in this position.

## D (Drive)

**Note:** A shift will occur only when your vehicle speed and the engine speed are appropriate.

**Note:** You may temporarily override the current gear selected using the **+** and **-** buttons.

Select drive to shift automatically through the forward gears.

The transmission will select the appropriate gear for optimum performance based on ambient temperature, road gradient, vehicle load and your input.

## Sport Mode and Manual Shifting

### Sport Mode

**Note:** In sport mode the transmission operates as normal but gears are selected more quickly and at higher engine speeds.

**Note:** In sport mode **S** will be shown in the information display.

Switch on sport mode by moving the transmission selector lever to position **S**. Sport mode will remain on until either you shift manually up or down the gears using **+** and **-** or move the transmission selector lever to position **D**.

### Manual Shifting

#### WARNINGS



Do not hold the buttons permanently in **-** or **+**.

#### WARNINGS



The transmission will automatically downshift when the engine speed is too low.

Press the **-** button to shift down and press the **+** button to shift up.

Gears may be skipped by pressing the buttons repeatedly at short intervals.

Manual mode also provides a kickdown function. See Kickdown.

## Hints on Driving With an Automatic Transmission

#### WARNING



Do not idle the engine for long periods of time in drive with the brakes applied.

## Moving Off

1. Release the parking brake.
2. Release the brake pedal and press the accelerator pedal.

## Stopping

1. Release the accelerator pedal and press the brake pedal.
2. Apply the parking brake.
3. Move the transmission selector lever to **N** or **P**.

## Kickdown

Press the accelerator pedal fully with the transmission selector lever in the drive position to select the next lowest gear for optimum performance. Release the accelerator pedal when you no longer require kickdown.

# Transmission

## If Your Vehicle Gets Stuck In Mud or Snow

**Note:** Do not rock your vehicle if the engine is not at normal operating temperature or damage to the transmission may occur.

**Note:** Do not rock your vehicle for more than a minute or damage to the transmission and tyres may occur, or the engine may overheat.

If your vehicle gets stuck in mud or snow, it may be rocked out by shifting between forward and reverse gears, stopping between shifts in a steady pattern. Press lightly on the accelerator in each gear.

## Emergency Park Position Release Lever

### WARNINGS



Do not drive your vehicle until you verify that the brake lamps are working.



If the parking brake is fully released, but the brake warning lamp remains illuminated, the brakes may not be working correctly. See an authorised dealer.

Use the lever to move the transmission selector lever from the park position in the event of an electrical malfunction or if your vehicle battery has no charge.

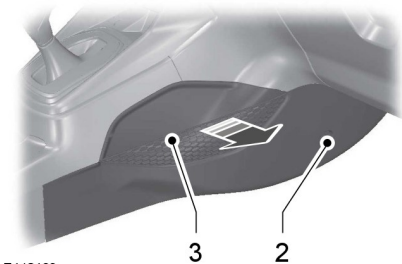

E142193

1. Apply the parking brake and switch the ignition off before performing this procedure.
2. Remove the retaining screw.
3. Remove the centre console side panel.

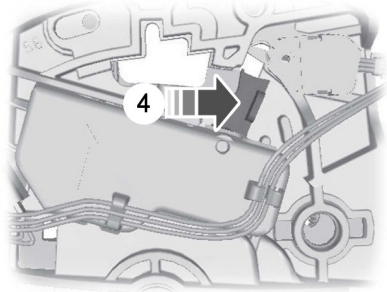

E142214

**Note:** The lever is pink.

4. Apply the brake pedal. Using a suitable tool rotate the lever forward while pulling the transmission selector lever out of the park position and into the neutral position.

**Note:** See an authorised dealer as soon as possible if this procedure is used.

## HILL START ASSIST

### WARNINGS



The system does not replace the parking brake. When you leave your vehicle, always apply the parking brake and move the transmission selector lever into position **P** (Park).



You must remain in your vehicle once you have activated the system.



During all times, you are responsible for controlling your vehicle, supervising the system and intervening, if required.

# Transmission

---

## WARNINGS



If the engine is revved excessively, or if a malfunction is detected, the system will be deactivated.

The system makes it easier to pull away when your vehicle is on a slope without the need to use the parking brake.

When the system is active, your vehicle will remain stationary on the slope for two to three seconds after you release the brake pedal. This allows you time to move your foot from the brake to the accelerator pedal. The brakes are released automatically once the engine has developed sufficient drive to prevent your vehicle from rolling down the slope. This is an advantage when pulling away on a slope, (for example from a car park ramp, traffic lights or when reversing uphill into a parking space).

The system will activate automatically on any slope which can result in significant vehicle rollback.

## Using Hill Start Assist

1. Press the brake pedal to bring your vehicle to a complete standstill. Keep the brake pedal pressed.
2. If the sensors detect that your vehicle is on a slope, the system will be activated automatically.
3. When you remove your foot from the brake pedal, your vehicle will remain on the slope without rolling away for approximately two or three seconds. This hold time will automatically be extended if you are in the process of driving off.
4. Drive off in the normal manner. The brakes will be released automatically.

## Switching the System On and Off

**Note:** *The system can only be switched on and off for manual transmissions.*

**Note:** *Once you have switched off the system, it will remain off until you switch it on again.*

Your vehicle comes with the system already enabled. If desired, you can disable the feature: See **General Information** (page 58).

# Brakes

## GENERAL INFORMATION

### WARNING



The system does not relieve you of your responsibility to drive with due care and attention.

**Note:** Occasional brake noise is normal. If a metal-to-metal, continuous grinding or continuous squeal sound is present, the brake linings may be worn-out. If the vehicle has continuous vibration or shudder in the steering wheel while braking, have your vehicle checked by an authorised dealer.

**Note:** Brake dust may accumulate on the wheels, even under normal driving conditions. Some dust is inevitable as the brakes wear. See **Cleaning the Alloy Wheels** (page 154).

Wet brakes result in reduced braking efficiency. Gently press the brake pedal a few times when driving from a car wash or standing water to dry the brakes.

### Emergency Brake Assist

Emergency brake assist detects when you brake heavily by measuring the rate at which you press the brake pedal. It provides maximum braking efficiency as long as you press the pedal. Emergency brake assist can reduce stopping distances in critical situations.

### Anti-lock Brake System

This system helps you maintain steering control and vehicle stability during emergency stops by keeping the brakes from locking.

## HINTS ON DRIVING WITH ANTI-LOCK BRAKES

**Note:** When the system is operating, the brake pedal will pulse and may travel further. Maintain pressure on the brake pedal. You may also hear a noise from the system. This is normal.

The ABS will not eliminate the risks when:

- you drive too closely to the vehicle in front of you
- your vehicle is aquaplaning
- you take corners too fast
- the road surface is poor.

## PARKING BRAKE

### Vehicles With Automatic Transmission

#### WARNING



Always set the parking brake fully and leave your vehicle with the transmission selector lever in position P.

**Note:** If you park your vehicle on a hill and facing uphill move the transmission selector lever to position P and turn the steering wheel away from the kerb.

**Note:** If you park your vehicle on a hill and facing downhill move the transmission selector lever to position P and turn the steering wheel toward the kerb.

### Vehicles With Manual Transmission

**Note:** If you park your vehicle on a hill and facing uphill select first gear and turn the steering wheel away from the kerb.

**Note:** If you park your vehicle on a hill and facing downhill select reverse gear and turn the steering wheel toward the kerb.

# Brakes

---

## All Vehicles

**Note:** *Do not press the release button while pulling the lever up.*

To apply the parking brake:

1. Press the foot brake pedal firmly.
2. Pull the parking brake lever up to its fullest extent.

To release the parking brake:

1. Press the brake pedal firmly.
2. Pull the lever up slightly.
3. Press the release button and push the lever down.



# Stability Control

## PRINCIPLE OF OPERATION

### Electronic Stability Program

#### WARNING



The system does not relieve you of your responsibility to drive with due care and attention.

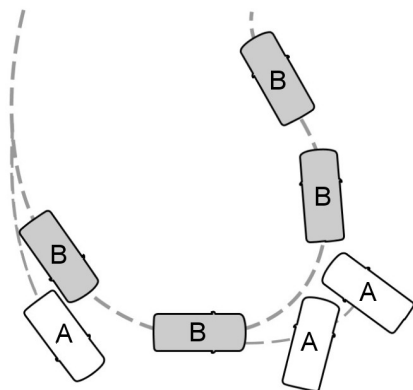

E72903

- A Without ESP
- B With ESP

The system supports stability when your vehicle starts to slide away from your intended path. This is performed by braking individual wheels and reducing engine torque as needed.

The system also provides an enhanced traction control function by reducing engine torque if the wheels spin when you accelerate. This improves your ability to pull away on slippery roads or loose surfaces, and improves comfort by limiting wheel spin in hairpin bends.

### Stability Control Warning Lamp

While driving, it flashes when the system is operating. See **Warning Lamps and Indicators** (page 53).

## USING STABILITY CONTROL

**Note:** *The system automatically switches on every time you switch the ignition on.*

You can switch the system on and off using the information display. See **General Information** (page 58).

# Parking Aids

---

## PRINCIPLE OF OPERATION

### WARNINGS



The system does not relieve you of your responsibility to drive with due care and attention.



If your vehicle has a trailer tow module not approved by us, the system may not correctly detect obstacles.



The sensors may not detect objects in heavy rain or other conditions that cause disruptive reflections.



The sensors may not detect objects with surfaces that absorb ultrasonic waves.



The system does not detect obstacles moving away from your vehicle. They will only be detected shortly after they start to move toward your vehicle.



Take particular care when reversing with a tow ball arm or rear fitted accessories e.g. a bicycle carrier, as the rear parking aid will only indicate the distance from the bumper to the obstacle.



If you use a high pressure spray to wash your vehicle, only spray the sensors briefly from a distance not less than 8 inches (20 centimetres).

---

**Note:** *If your vehicle has a tow ball arm, the system is switched off automatically when any trailer lamps (or lighting boards) are connected to the 13-pin socket via a trailer tow module we have approved.*

**Note:** *Keep the sensors free from dirt, ice and snow. Do not clean with sharp objects.*

**Note:** *The system may emit false tones if it detects a signal using the same frequency as the sensors or if your vehicle is fully laden.*

**Note:** *The outer sensors may detect the side walls of a garage. If the distance between the outer sensor and the side wall remains constant for three seconds, the tone will switch off. As you continue, the inner sensors will detect rearward objects.*

## PARKING AID

### WARNINGS



To help avoid personal injury, read and understand the limitations of the system as contained in this section. Sensing is only an aid for some (generally large and fixed) objects when moving in reverse on a flat surface at parking speeds. Traffic control systems, inclement weather, air brakes and external motors and fans may also affect the function of the sensing system. This may include reduced performance or a false activation.



To help avoid personal injury, always use caution when moving in reverse and when using the sensing system.



This system is not designed to prevent contact with small or moving objects. The system is designed to provide a warning to assist the driver in detecting large stationary objects to avoid damaging the vehicle. The system may not detect smaller objects, particularly those close to the ground.



Certain add-on devices such as large trailer hitches, bike or surfboard racks and any device that may block the normal detection zone of the system, may create false audible warnings.

---

**Note:** *Keep the sensors located on the bumper or fascia free from snow, ice and large accumulations of dirt. If the sensors are covered, the system's accuracy can be affected. Do not clean the sensors with sharp objects.*

# Parking Aids

**Note:** *If your vehicle sustains damage to the bumper or fascia, leaving it misaligned or bent, the sensing zone may be altered causing inaccurate measurement of obstacles or false alarms.*

The system warns you of obstacles within a certain range of the bumper area.

When receiving a detection warning, the radio volume is reduced to a predetermined level. After the warning goes away, the radio volume returns to the previous level.

## Rear Sensing System

The rear sensors are only active when you move the transmission selector lever to position **R** (reverse). As your vehicle moves closer to the obstacle, the rate of the audible warning increases. When the obstacle is fewer than 12 inches (30 centimetres) away, the audible warning sounds continuously. If a stationary or receding object is detected farther than 12 inches (30 centimetres) from the side of your vehicle, the audible warning sounds for only three seconds. Once the system detects an object approaching, the audible warning sounds again.

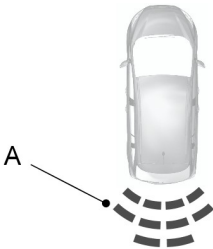

E130178

- A Coverage area of up to 72 inches (183 centimetres) from the rear bumper (with a decreased coverage area at the outer corners of the bumper).

The system detects certain objects when you move the transmission selector lever to position **R** (reverse):

- and your vehicle is moving toward a stationary object at a speed of 3 mph (5 km/h) or less
- but your vehicle is not moving, and a moving object is approaching the rear of your vehicle at a speed of 3 mph (5 km/h) or less
- and your vehicle is moving at a speed of less than 3 mph (5 km/h) and a moving object is approaching the rear of your vehicle at a speed of less than 3 mph (5 km/h).

Move the transmission selector lever from position **R** (reverse) to turn the system off. If a fault is present in the system, a warning message appears in the information display and does not allow you to switch the system on.

## Front and Rear Sensing System

The system turns on automatically whenever you switch the ignition on. It becomes active when you press the parking aid button or move the transmission selector lever into position **R** or reverse gear and your vehicle speed is below 10 mph (16 km/h).

# Parking Aids

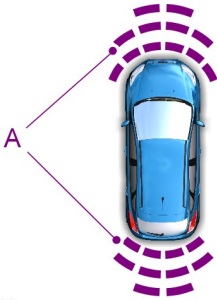

E130382

- A Coverage area of up to 31 inches (80 centimetres) from the front of your vehicle, up to 72 inches (183 centimetres) from the rear bumper and about 6–14 inches (15–35 centimetres) to the side of the front end of your vehicle.

The system sounds an audible warning when obstacles are near either bumper in the following manner:

- Objects detected by the front sensors are indicated by a high-pitched tone from the front speakers.
- Objects detected by the rear sensors are indicated by a lower pitched tone from the rear speakers. As your vehicle moves closer to the obstacle, the rate of the audible warning increases.
- The sensing system reports the obstacle which is closest to the front or rear of your vehicle. For example, if an obstacle is 24 inches (60 centimetres) from the front of your vehicle and at the same time, an obstacle is only 16 inches (40 centimetres) from the rear of your vehicle, the lower pitched tone sounds.



- An alternating audible warning sounds from the front and rear if there are objects at both bumpers that are closer than 12 inches (30 centimetres).
- If a stationary or receding object is detected further than 12 inches (30 centimetres) from the side of your vehicle, the audible warning sounds for only three seconds. Once the system detects an object approaching, the audible warning sounds again.

For specific information on the reverse sensing portion of the system, refer to that section.

Press the button to switch the system off. Press the button or move the transmission selector lever to position **R** (reverse) to turn the system on again. For item location: See **At a Glance** (page 8).

## REAR VIEW CAMERA

### WARNINGS

-  The operation of the camera may vary depending on the ambient temperature, vehicle and road conditions.
-  The distances shown in the display may differ from the actual distance.
-  Do not place objects in front of the camera.

The camera is located on the liftgate near the handle.

# Parking Aids

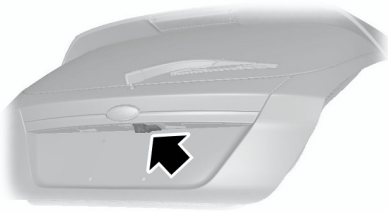

E147796

## Switching the Rear View Camera On

### WARNING



The camera may not detect objects that are close to your vehicle.

Switch the ignition and the audio unit on.

Press the parking aid switch in the instrument panel or move the transmission selector lever to position **R** (reverse).

The image is displayed on the screen.

The lamp in the switch illuminates when the system is switched on.

The camera may not operate correctly in the following conditions:

- Dark areas.
- Intense light.
- If the ambient temperature increases or decreases rapidly.
- If the camera is wet, for example in rain or high humidity.
- If the camera's view is obstructed, for example by mud.

## Using the Display

### WARNINGS



Obstacles above the camera position will not be shown. Inspect the area behind your vehicle if necessary.

### WARNINGS



Marks are for general guidance only, and are calculated for vehicles in maximum load conditions on an even road surface.

The lines show the distance from the outer edge of the front tyre plus two inches (51 millimetres) and the rear bumper.

# Parking Aids

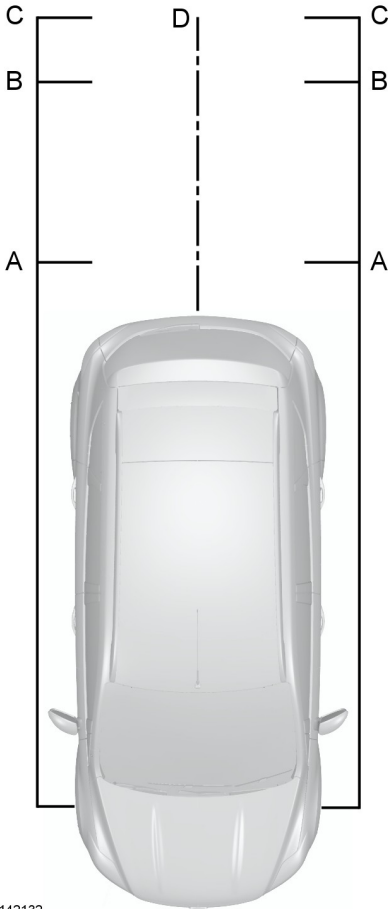

C Green - 24 - 35 inches (0.6 - 0.9 metre)

D Black - centre line of the projected vehicle path

**Note:** The green line is extended from 35 inches (0.9 metre) up to a distance of 126 inches (3.2 metres).

**Note:** When reversing with a trailer, the lines on the screen are not shown. The camera will show your vehicle direction and not the trailer.

## Switching the Rear View Camera Off

**Note:** The system will automatically switch off once your vehicle speed has reached approximately 7 mph (12 km/h).

Press the parking aid switch in the instrument panel. For item location: See **At a Glance** (page 8).

## Vehicles with Parking Aid

The display will additionally show a coloured distance bar. This guide indicates the distance from the rear bumper to the detected obstacle.

These are colour coded as follows:

- Green - 24 - 71 inches (0.6 to 1.8 metres).
- Amber - 12 - 24 inches (0.3 to 0.6 metre).
- Red - 12 inches (0.3 metre) or less.

E142132

A Red - up to 12 inches (0.3 metre)

B Amber - 12 - 24 inches (0.3 - 0.6 metre)

# Cruise Control

## PRINCIPLE OF OPERATION

### WARNING

 The system does not relieve you of your responsibility to drive with due care and attention.

Cruise control allows you to control your speed using the switches on the steering wheel. You can use cruise control when you exceed approximately 20 mph (30 km/h).

## USING CRUISE CONTROL

### WARNING

 Do not use cruise control in heavy traffic, on twisty roads or when the road surface is slippery.

## Switching Cruise Control On



E102679

**Note:** The system is ready for you to set a speed.

## Setting a Speed

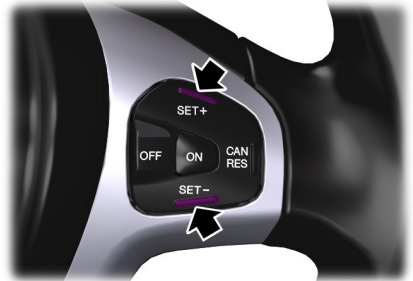

E102680

Press to store and maintain your current speed. The cruise control indicator will illuminate. See **Warning Lamps and Indicators** (page 53).

## Changing the Set Speed

### WARNING

 When you are going downhill, your speed may increase above the set speed. The system will not apply the brakes. Change down a gear to assist the system in maintaining the set speed.

**Note:** If you accelerate by pressing the accelerator pedal, the set speed will not change. When you release the accelerator pedal, your vehicle will return to the speed that you previously set.

# Cruise Control

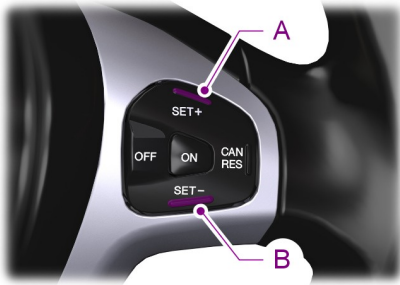

E102681

- A Accelerate
- B Decelerate

## Canceling the Set Speed



E102682

**Note:** The system will no longer control your speed. The cruise control indicator will not illuminate but the system will retain the speed that you previously set.

You can also press the brake pedal to cancel the set speed.

## Resuming the Set Speed

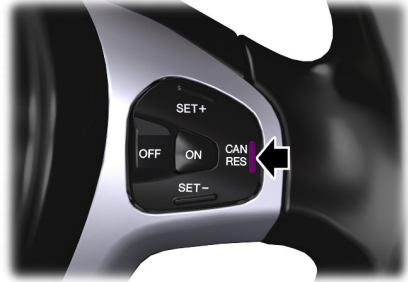

E102682

The cruise control indicator will illuminate and the system will attempt to resume the speed that you previously set.

## Switching Cruise Control Off

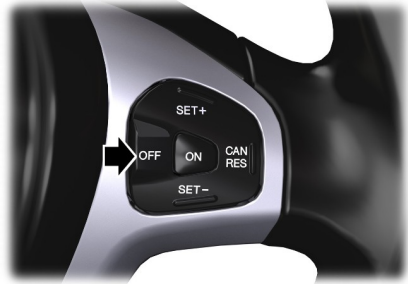

E102683

The system will not retain the speed that you previously set. The cruise control indicator will not illuminate.















# Driving Aids



## ACTIVE CITY STOP

### General Information

#### WARNINGS

-  The system does not relieve you of your responsibility to drive with due care and attention.
-  At all times you are responsible for controlling your vehicle, supervising the system and intervening if required.
-  Never look directly into the sensor with any type of object. There is a risk of eye injury.
-  If the sensor becomes blocked the system may not function.
-  To achieve full system performance, you must bed the braking system in. See **Running-In** (page 121).
-  The system performance may vary depending on your vehicle and road conditions.
-  The system will not react to vehicles driving in a different direction.
-  The system will not react to bicycles, motorcycles, people or animals.
-  When the ignition is on the sensor will constantly transmit a laser beam.
-  The system will not operate during harsh acceleration and steering.
-  In cold and severe weather conditions the system may not function. Rain, snow, spray and ice can all influence the sensor.
-  Do not carry out windscreen repairs in the immediate area surrounding the sensor.

#### WARNINGS

-  If you install a windscreen not approved by us, the system may not function correctly.
-  If the engine stops after the system has been switched on, the hazard warning flashers will turn on.
-  The system may not function when driving around sharp bends.

**Note:** *Keep the windscreen free from obstructions such as bird droppings, insects, snow or ice.*

**Note:** *Keep the bonnet free of ice and snow, otherwise the system may not function correctly.*

A sensor is mounted behind the interior rear view mirror. It continuously monitors conditions to decide when to intervene.

The system is designed to help you reduce low speed collisions into the rear of another vehicle. It will also help you reduce the impact damage or potentially avoid the collision completely.

The system operates at speeds below approximately 19 mph (30 km/h) by applying the brakes when the sensor detects that a collision is likely.

You must depress the brake pedal to obtain full braking force.

When the system is braking or has automatically applied the brakes, a message will be shown in the information display.

### Using Active City Stop

#### Switching the System Off and On

**Note:** *The system is on by default.*

**Note:** *In certain situations, it is advisable to disable the system, for example driving off road when objects may cover the windscreen.*

# Driving Aids

You can switch the system off and on using the information display. See **General Information** (page 58).

## Active City Stop Relearning Procedure



**Note:** *When you disconnect the battery, the system will go through a relearning procedure. During this time the system will not be available.*

You must drive your vehicle above 31mph (50 km/h) in a straight line for the procedure to complete. This procedure may take several minutes.

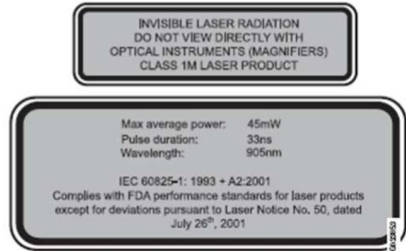
## Laser Sensor Information



## WARNINGS





-  Invisible laser radiation. Do not view directly with optical instruments (magnifiers). Class 1M laser product.
-  IEC 60825-1: 1993 + A2:2001. Complies with FDA performance standards for laser products except for deviation pursuant to Laser Notice No. 50, dated July 26th, 2001.

Item	Specification
Max average power	45mW
Pulse duration	33ns
Wavelength	905nm

# Load Carrying

## GENERAL INFORMATION

### WARNINGS

-  Use load securing straps to an approved standard, e.g. DIN.
-  Make sure that you secure all loose items properly.
-  Place luggage and other loads as low and as far forward as possible within the luggage or loadspace.
-  Do not drive with the tailgate or rear door open. Exhaust fumes may enter your vehicle.
-  Do not exceed the maximum front and rear axle loads for your vehicle. See **Vehicle Identification Plate** (page 167).
-  Do not allow items to contact the rear windows.

## LUGGAGE ANCHOR POINTS



E142324

## REAR UNDER FLOOR STORAGE

### Adjustable Load Floor

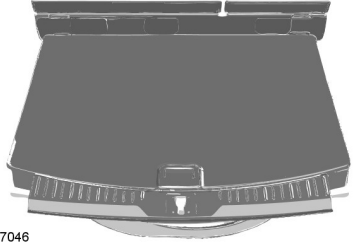

E147046

Vehicles with the standard size spare tyre can adjust the load floor to two positions. The load floor can be placed on either the high or the low position on shelves located at the rear of the luggage compartment trim.



# Load Carrying

## CARGO NETS

### Installing and Removing the Net

#### Installing the Net

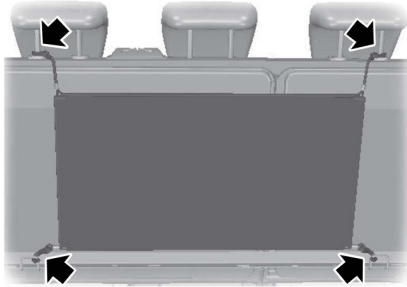

E142503

1. Raise the rear outer head restraints. See **Head Restraints** (page 76).
2. Attach the top securing clips to the head restraint guides.
3. Attach the bottom securing clips to the bottom anchor points.

#### Removing the Net

1. Raise the rear outer head restraints. See **Head Restraints** (page 76).
2. Remove the top and bottom securing clips.

## LUGGAGE COVERS

### WARNING



Do not place objects on the luggage cover.

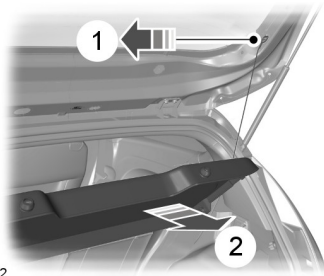

E72512

## DOG GUARD

### WARNING



Keep a small distance between the dog guard and the rear seats.

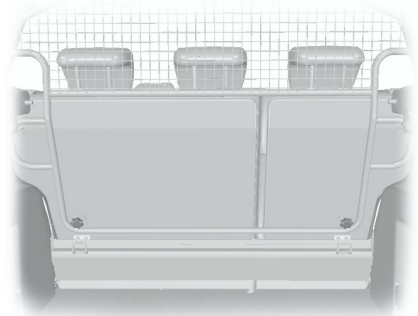

E142506

1. Attach the dog guard to the upper and lower anchor points. Tighten the handwheels.

# Load Carrying

---

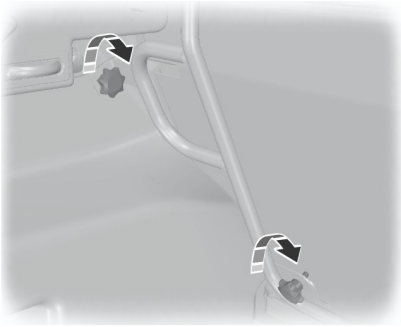

E142507

# Towing

## TOWING A TRAILER

### WARNINGS



Do not exceed 62 mph (100 km/h).



The rear tyre pressures must be increased by 3 psi (0.2 bar) above specification. See **Technical Specifications** (page 164).



Do not exceed the maximum gross train weight stated on your vehicle identification plate. See **Vehicle Identification Plate** (page 167).



Do not exceed the maximum permissible nose weight, i.e. vertical weight on the tow ball, of 110 pounds (50 kilogrammes).



The electrical system is not suitable for towing trailers with more than one rear fog lamp.

**Note:** *Not all vehicles are suitable or approved to have tow bars fitted. Check with your dealer first.*

Place loads as low and central to the axle(s) of the trailer as possible. If you are towing with an unladen vehicle, the load in the trailer should be placed toward the nose, within the maximum nose load, as this gives the best stability.

The stability of your vehicle to trailer combination is very much dependant on the quality of the trailer.

In high altitude regions above 3 281 feet (1 000 metres), the stipulated maximum permitted gross train weight must be reduced by 10% for every additional 3 281 feet (1 000 metres).

## Steep Gradients

### WARNING



The anti-lock braking system does not control the overrun brake on the trailer.

Change down a gear before you reach a steep downhill gradient.

## TOW BALL

### WARNINGS



When not in use, always transport the tow ball arm securely fastened in the luggage compartment.



Take special care when fitting the tow ball arm as the safety of your vehicle and the trailer depends on

this.



Do not use any tools for mounting or dismantling the tow ball arm.



Do not modify the trailer coupling.



Do not disassemble or repair the tow ball arm.

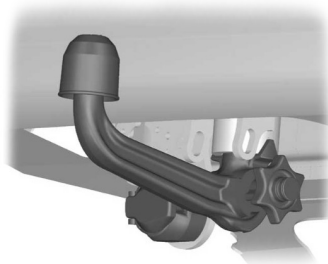

E71328

A 13-pin trailer socket and the tow ball arm seat are provided under the rear bumper. Turn the trailer socket down through 90 degrees until it engages in the end position.

# Towing

## Unlocking the Tow Ball Arm Mechanism

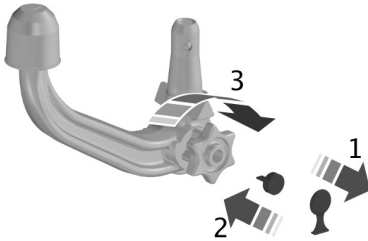

E71329

1. Remove the protecting cap.
2. Insert the key and turn it clockwise to unlock.
3. Hold the tow ball arm. Pull the handwheel out and turn it clockwise until it clicks.

**Note:** *The red mark on the handwheel must align with the green mark on the tow ball.*

4. Release the handwheel. The tow ball arm is unlocked.

## Inserting the Tow Ball Arm

### WARNING



The tow ball arm may only be inserted when completely unlocked.

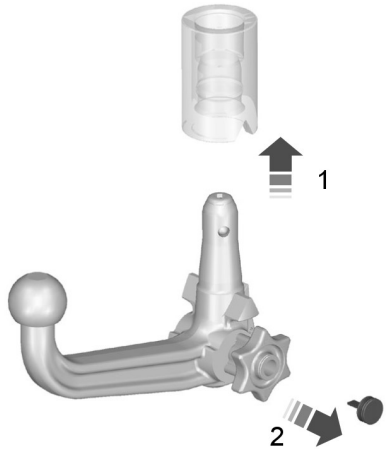

E71330

**Note:** *Pull out the plug.*

1. Insert the tow ball arm vertically and press it upwards until it engages.

**Note:** *Do not hold your hand near the handwheel.*

**Note:** *The green mark on the handwheel must align with the green mark on the tow ball.*

2. Turn the key anti-clockwise and remove the key to lock the tow ball.
3. Pull the protecting cap from the key bow and press it onto the lock.

## Driving With a Trailer

### WARNING



If any of the below conditions cannot be met, do not use the tow bar and have it checked by an authorised dealer.

# Towing

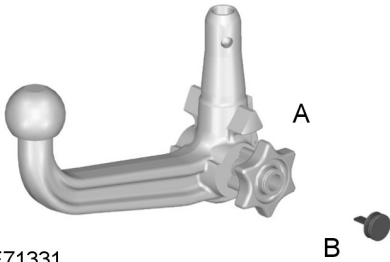

E71331

Before starting your journey, make sure that the tow ball arm is correctly locked. Check that:

- the green marks are aligned
- the handwheel (A) is correctly fitted to the tow ball arm
- you have removed the key (B)
- the tow ball arm is securely positioned.

## Removing the Tow Ball Arm

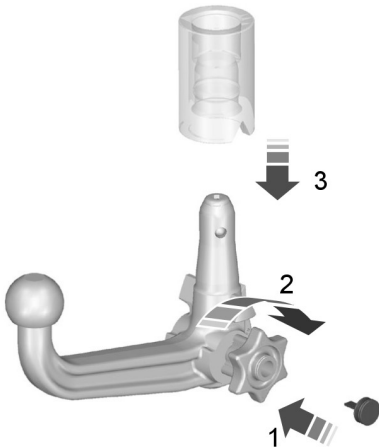

E71332

**Note:** *Unhitch the trailer.*

1. Remove the protecting cap. Press the cap into the key bow. Insert the key and unlock.
2. Hold the tow ball arm. Pull the handwheel out, turn it clockwise against the stop.
3. Remove the tow ball arm.
4. Release the handwheel.

When unlocked in this way, the tow ball arm can be reinserted at any time.

## Driving Without a Trailer

### WARNING



Never unlock the tow ball arm with the trailer attached.

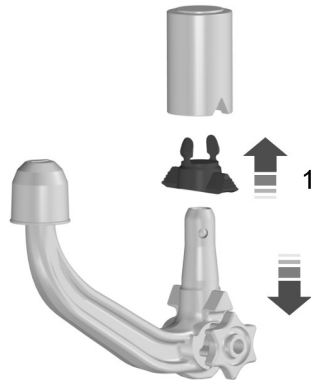

E94771

Remove the tow ball arm. Insert the plug into its seat (1).



# Towing

## Maintenance

### WARNING



Remove the tow ball arm and protect the seat with the plug before steam cleaning your vehicle.

Keep the system clean. Periodically lubricate bearings, sliding surfaces, and locking balls with resin-free grease or oil and the lock with graphite.

In case of loss, replacement keys are available from the manufacturer by stating the number on the lock cylinder.

## TOWING POINTS

### WARNING



The towing eye has a left-hand thread. Turn it anticlockwise to install it. Make sure that the towing eye is fully tightened.

## Front Towing Eye

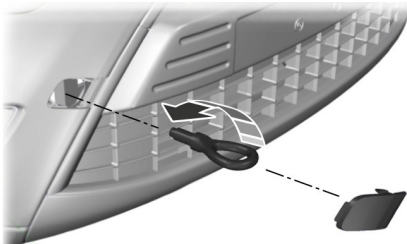

E99490

Space is provided in the spare wheel well. You must carry the towing eye in your vehicle at all times.

Remove the cover and install the towing eye.

## Rear Towing Hook

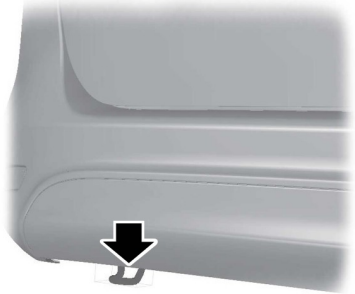

E142319

**Note:** If your vehicle has a tow bar, use this to tow other vehicles.

## TOWING THE VEHICLE ON FOUR WHEELS

### All Vehicles

### WARNINGS



You must switch the ignition on when your vehicle is being towed.



The brake and steering assistance will not operate unless the engine is running. Press the brake pedal harder and allow for increased stopping distances and heavier steering.



Too much tension in the tow rope could cause damage to your vehicle or the vehicle that is towing.



Do not use a rigid tow bar on the front towing eye.



When towing your vehicle you must select neutral.

Drive off slowly and smoothly without jerking the vehicle that is being towed.

# Towing

---

## Vehicles With Automatic Transmission

### WARNINGS



If a speed of 12 mph (20 km/h) and a distance of 12 miles (20 kilometres) is to be exceeded the drive wheels must be lifted clear of the ground.



It is recommended not to tow with the drive wheels on the ground. However, if it is required to move your vehicle from a dangerous location, do not tow your vehicle faster than 12 mph (20 km/h) or further than 12 miles (20 kilometres).



Do not tow your vehicle backward.



In the event of a mechanical failure of the transmission the drive wheels must be lifted clear of the ground.



Do not tow your vehicle if the ambient temperature is below 32°F (0°C).

---

# Driving Hints

---

## RUNNING-IN

### Tyres

#### WARNING



New tyres need to be run-in for approximately 300 miles (500 kilometres). During this time, you may experience different driving characteristics.

---

### Brakes and Clutch

#### WARNING



Avoid heavy use of the brakes and clutch if possible for the first 100 miles (150 kilometres) in town and for the first 1000 miles (1500 kilometres) on motorways.

---

### Engine

#### WARNING



Avoid driving too fast during the first 1000 miles (1500 kilometres). Vary your speed frequently and change up through the gears early. Do not labour the engine.

---

## COLD WEATHER PRECAUTIONS

The functional operation of some components and systems can be affected at temperatures below -13°F (-25°C).

## DRIVING THROUGH WATER

#### WARNINGS



Drive through water in an emergency only and not as part of normal driving.

#### WARNINGS



Engine damage can occur if water enters the air filter.

---

In an emergency, you can drive your vehicle through water to a maximum depth of 8 inches (200 millimetres) and at a maximum speed of 6 mph (10 km/h). You must take extra care when driving through flowing water.

When driving in water, maintain a low speed and do not stop your vehicle. After driving through water and as soon as it is safe to do so:

- Depress the brake pedal lightly to check that the brakes are functioning correctly.
- Check that the horn works.
- Check that your vehicle's lamps are fully operational.
- Check the power assistance of the steering system.

## FLOOR MATS

#### WARNING



Make sure that the floor mat is secured properly using the appropriate fixings, and do not position the floor mat so that it interferes with the operation of the pedals.

---

# Roadside Emergencies

## HAZARD WARNING FLASHERS

**Note:** Depending on applicable laws and regulations in the country for which your vehicle was originally built, the hazard warning flashers may flash if you brake heavily.



For item location: See **At a Glance** (page 8).

## FIRST AID KIT

Space is provided in the luggage compartment.

## WARNING TRIANGLE

Space is provided in the luggage compartment.

## JUMP-STARTING THE VEHICLE

### WARNINGS



Do not use fuel lines, engine rocker covers or the intake manifold as grounding points.



Connect batteries with only the same nominal voltage.



Always use jumper cables with insulated clamps and adequate size cable.

**Note:** Do not disconnect the battery from your vehicle's electrical system.

## To Connect the Booster Cables

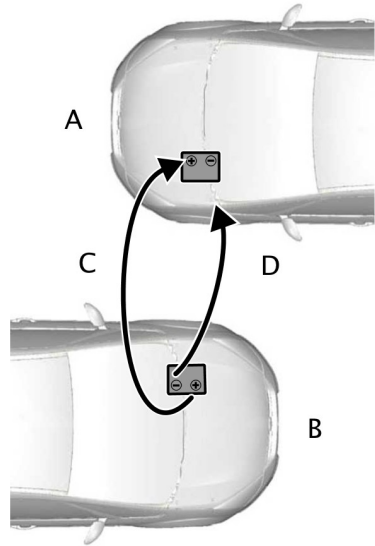

E102925

- A Flat battery vehicle
- B Booster battery vehicle
- C Positive connection cable
- D Negative connection cable

1. Position the vehicles so that they do not touch one another.
2. Switch off the engine and any electrical equipment.
3. Connect the positive (+) terminal of vehicle B with the positive (+) terminal of vehicle A (cable C).

# Roadside Emergencies

---



E102923

4. Connect the negative (-) terminal of vehicle B to the ground connection of vehicle A (cable D).

## WARNINGS



Do not connect directly to the negative (-) terminal of the flat battery.



Make sure that the cables are clear of any moving parts and fuel delivery system parts.

---

## To Start the Engine

1. Run the engine of vehicle B at a moderately high speed.
2. Start the engine of vehicle A.
3. Run both vehicles for a minimum of three minutes before disconnecting the cables.

## WARNING



Do not switch on the headlamps when disconnecting the cables. The peak voltage could blow the bulbs.

---

Disconnect the cables in the reverse order.

# Fuses

---

## FUSE BOX LOCATIONS

### Engine Compartment Fuse Box

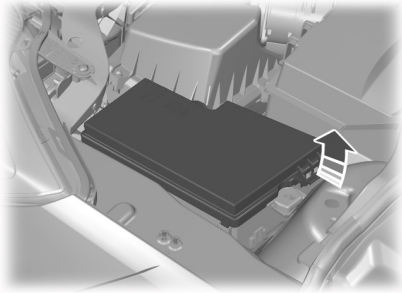

E78332

### Passenger's Compartment Fuse Box

This fuse box is located behind the glove box. Open the glove box and empty the contents. Press the sides inwards and swivel the glove box downward.

# Fuses

## FUSE SPECIFICATION CHART

### Engine Compartment Fuse Box

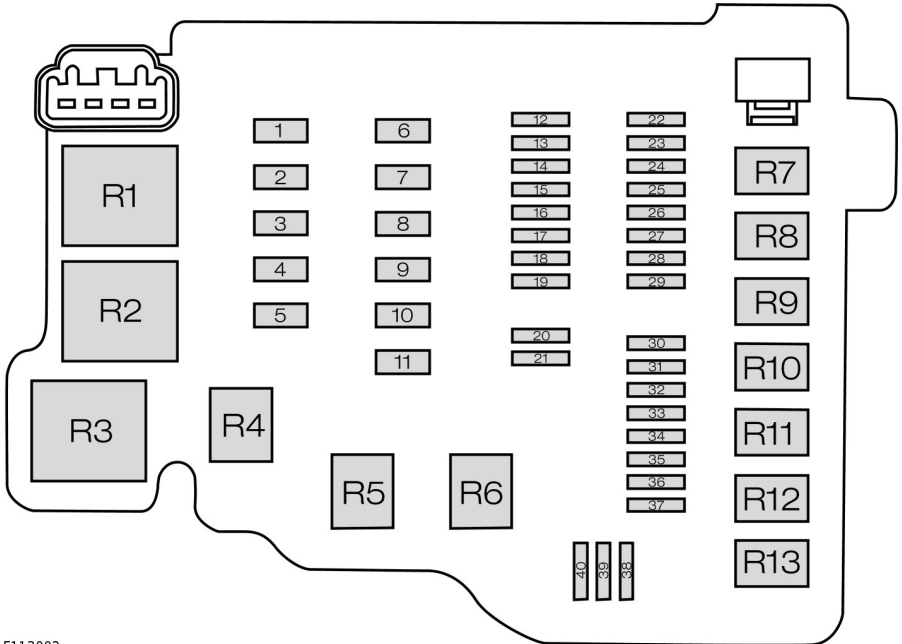

E113002

Fuse	Fuse rating	Circuits protected
1	40 A	Anti-lock braking system module
1	30 A	Anti-lock braking system, electronic stability program module
2	60 A	Cooling system fan high speed
3	40 A	Cooling system fan
3	30 A	Cooling system fan low speed
4	30 A	Heater blower
5	60 A	Passenger's compartment fuse box supply (battery)

## Fuses

<b>Fuse</b>	<b>Fuse rating</b>	<b>Circuits protected</b>
6	30 A	Body control module
7	60 A	Passenger's compartment fuse box supply (ignition)
8	60 A	Glow plugs
8	50 A	DPS6 module
9	40 A	Heated windscreen
10	40 A	Heated windscreen
11	30 A	Starter relay
12	10 A	Main beam left-hand relay
13	10 A	Main beam right-hand relay
14	15 A	Run on pump
15	20 A	Ignition coil
16	15 A	Powertrain control module, high and low cooling fan
17	15 A	Heated oxygen sensors (petrol engines)
17	20 A	Power supply module (diesel engines)
18	-	Not used
19	7.5A	Air condition controller
20	-	Not used
21	-	Not used
22	15 A	Lighting control battery supply
23	15 A	Front fog lamps
24	15 A	Direction indicators
25	15 A	Exterior lighting left-hand side
26	15 A	Exterior lighting right-hand side
27	7.5 A	Powertrain control module
28	20 A	Anti-lock braking system, electronic stability program
29	10 A	Air conditioning clutch
30	-	Not used



# Fuses

<b>Fuse</b>	<b>Fuse rating</b>	<b>Circuits protected</b>
31	-	Not used
32	20 A	Horn, battery saver, keyless vehicle module
33	20 A	Heated rear window
34	20 A	Fuel pump relay, diesel fuel heater
35	15 A	Cat1 alarm system
36	7.5A	Automatic transmission controller
37	25 A	Front door module left-hand side
38	25 A	Front door module right-hand side
39	25 A	Rear door module left-hand side
40	25 A	Rear door module right-hand side

<b>Relay</b>	<b>Circuits switched</b>
R1	Cooling system fan
R2	Not used
R3	Powertrain control module
R4	High beam
R5	Not used
R6	Not used
R7	Engine cooling fan
R8	Starter
R9	Air conditioning clutch
R10	Front fog lamps
R11	Fuel pump, diesel fuel heater
R12	Reversing lamp
R13	Heater blower

# Fuses

## Passenger's Compartment Fuse Box - Type 1

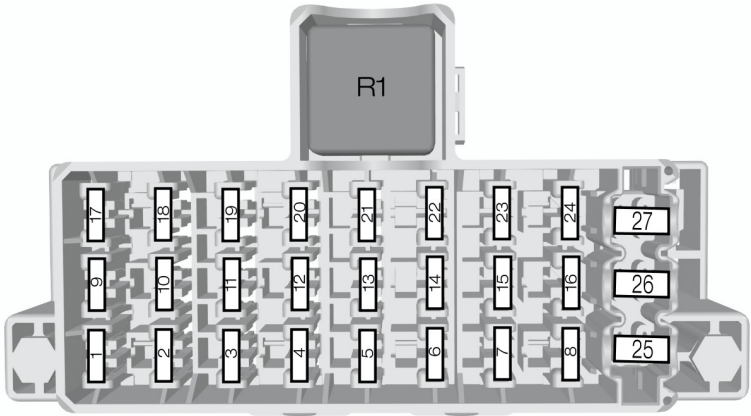

E125747

Fuse	Fuse rating	Circuits protected
1	7.5 A	Ignition, rain sensor, heated windscreen
2	10 A	Stop lamps
3	7.5 A	Reversing lamp, rear view camera
4	7.5 A	Headlamp levelling
5	-	Not used
6	15 A	Rear window wiper
7	15 A	Washer pump
8	-	Not used
9	15 A	Passenger's heated seat
10	15 A	Driver's heated seat
11	-	Not used
12	10 A	Airbag module

## Fuses

Fuse	Fuse rating	Circuits protected
13	10 A	Ignition, electric power assisted steering, instrument cluster, passive anti-theft system, anti-lock braking system
14	7.5 A	Powertrain control module, transmission selector lever, fuel pump
15	7.5 A	Audio system, instrument cluster
16	7.5 A	Heated windscreen
17	-	Not used
18	-	Not used
19	15 A	Data link connector
20	20 A	Multi function display, clock, internal scanner, heating vents, air conditioning panel
21	15 A	Audio system, navigation, bluetooth
22	7.5 A	Instrument cluster
23	7.5 A	Trailer module
24	7.5 A	Sync module antenna
25	-	Not used
26	30 A	Front wiper, left-hand side
27	30 A	Front wiper, right-hand side

Relay	Circuits switched
R1	Ignition

# Fuses

## Passenger's Compartment Fuse Box - Type 2

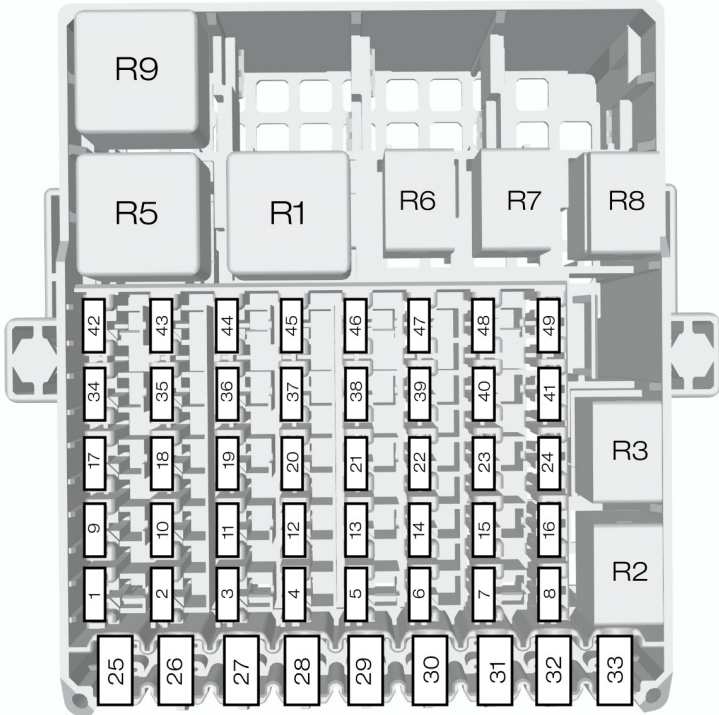

E125748

Fuse	Fuse rating	Circuits protected
1	7.5 A	Ignition, rain sensor, heated windscreen, dome lamp, interior mirror
2	10 A	Stop lamps
3	7.5 A	Reversing lamp
4	7.5 A	Headlamp levelling
5	-	Not used

## Fuses

<b>Fuse</b>	<b>Fuse rating</b>	<b>Circuits protected</b>
6	15 A	Rear window wiper
7	15 A	Washer pump
8	-	Not used
9	15 A	Passenger's heated seat
10	15 A	Driver's heated seat
11	-	Not used
12	10 A	Airbag module
13	10 A	Ignition, electric power assisted steering, instrument cluster, passive anti-theft system, anti-lock braking system
14	7.5 A	Powertrain control module, gear selector lever, fuel pump
15	7.5 A	Audio system, instrument cluster
16	7.5 A	Heated windscreen right-hand side
17	-	Not used
18	-	Not used
19	10 A	Data link connector
20	20 A	Trailer module
21	15 A	Audio system, navigation
22	7.5 A	Instrument cluster
23	7.5 A	Multi functional display, clock, internal scanner, heating vents, air conditioning panel
24	10 A	Sync module
25	-	Not used

## Fuses

<b>Fuse</b>	<b>Fuse rating</b>	<b>Circuits protected</b>
26	30 A	Front wiper, left-hand side
27	30 A	Front wiper, right-hand side
28	30 A	Voltage quality module
29	20 A	Rear power point
30	20 A	Cigar lighter, front power point
31	-	Not used
32	-	Not used
33	-	Not used
34	20 A	Keyless entry
35	20 A	Keyless entry
36	10 A	Data link connector
37	15 A	Ignition switch
38	-	Not used
39	-	Not used
40	-	Not used
41	-	Not used
42	7.5 A	Rear view camera
43	10 A	Active city stop module
44	-	Not used
45	-	Not used
46	-	Not used
47	-	Not used
48	-	Not used
49	-	Not used

# Fuses

Relay	Circuits switched
R1	Ignition
R2	Cigar lighter
R3	Not used
R4	Active city stop relay
R5	Not used
R6	Keyless entry (accessory)
R7	Keyless entry (ignition)
R8	Battery saver relay
R9	Heated windscreen left-hand side
R10	Heated windscreen right-hand side
R11	Not used
R12	Not used

## CHANGING A FUSE

### WARNINGS



Do not modify the electrical system of your vehicle in any way. Have repairs to the electrical system and the replacement of relays and high current fuses carried out by an authorised dealer.



Switch the ignition and all electrical equipment off before touching or attempting to change a fuse.



Fit a replacement fuse with the same rating as the one you have removed.

**Note:** You can identify a blown fuse by a break in the filament.

**Note:** All fuses, except high current fuses, are a push fit.

# Maintenance

## GENERAL INFORMATION

Have your vehicle serviced regularly to help maintain its roadworthiness and resale value. There is a large network of Ford authorised repairers that are there to help you with their professional servicing expertise. Authorised repairers are best qualified to service your vehicle properly and expertly, with a wide range of highly specialised tools.

In addition to regular servicing, we recommend that you carry out the following checks.

### WARNINGS



Switch the ignition off before touching or attempting adjustment of any kind.



Do not touch the electronic ignition system parts after you have switched the ignition on or when the engine is running. The system operates at high voltage.



Keep your hands and clothing clear of the engine cooling fan. Under certain conditions, the fan may continue to run for several minutes after you have switched the engine off.



Make sure that you fit filler caps securely after carrying out maintenance checks.

## Daily Checks

- Exterior lamps.
- Interior lamps.
- Warning lamps and indicators.

## Check When Refuelling

- Engine oil level. See **Engine Oil Check** (page 139).
- Brake fluid level. See **Brake and Clutch Fluid Check** (page 141).

- Washer fluid level. See **Washer Fluid Check** (page 141).
- Tyre pressures (when cold). See **Technical Specifications** (page 164).
- Tyre condition. See **Wheels and Tyres** (page 155).

## Monthly Checks

- Engine coolant level (engine cold). See **Engine Coolant Check** (page 140).
- Pipes, hoses and reservoirs for leaks.
- Air conditioning operation.
- Parking brake operation.
- Horn operation.
- Tightness of wheel nuts. See **Technical Specifications** (page 164).

## OPENING AND CLOSING THE BONNET

### Opening the Bonnet



E102165

1. Pull the bonnet release handle.



# Maintenance

---



E135852

2. Move the catch to the left.

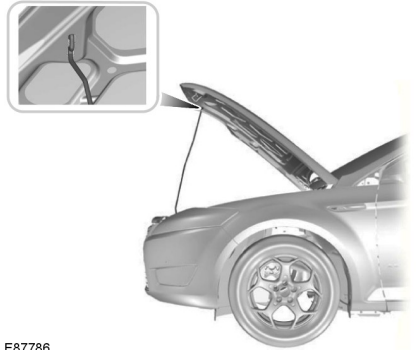

E87786

3. Open the bonnet and support it with the bonnet strut.

## Closing the Bonnet

1. Remove the bonnet strut from the catch and secure correctly after use.
2. Lower the bonnet and allow it to drop from under its own weight for the last 8 - 11 inches (20 - 30 centimetres).

**Note:** *Make sure that you have closed the bonnet correctly.*

# Maintenance

## UNDER BONNET OVERVIEW - 1.0L ECOBOOST (74KW/100PS)/1.0L ECOBOOST (90KW/120PS)

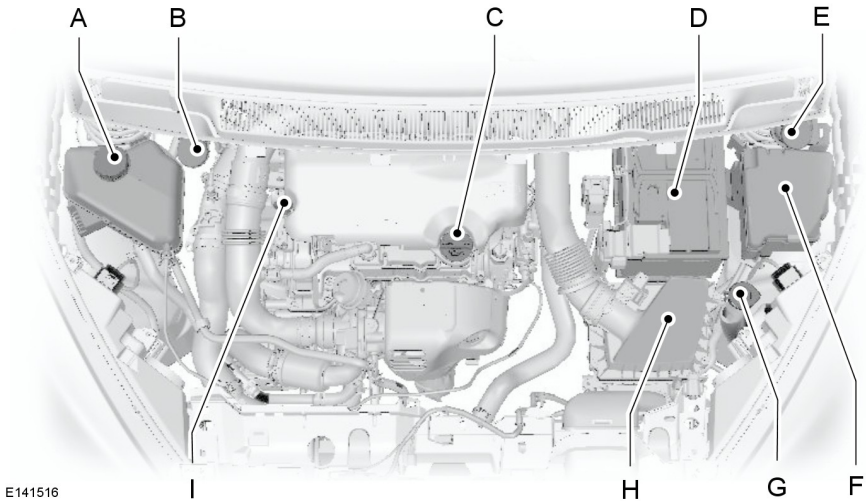

E141516

- A Engine coolant reservoir\*: See **Engine Coolant Check** (page 140).
- B Brake and clutch fluid reservoir (right-hand drive)\*: See **Brake and Clutch Fluid Check** (page 141).
- C Engine oil filler cap\*: See **Engine Oil Check** (page 139).
- D Battery: See **Changing the 12V Battery** (page 141).
- E Brake and clutch fluid reservoir (left-hand drive)\*: See **Brake and Clutch Fluid Check** (page 141).
- F Engine compartment fuse box. See **Fuses** (page 124).
- G Windscreen and rear window washer fluid reservoir: See **Washer Fluid Check** (page 141).
- H Air cleaner: No maintenance necessary.
- I Engine oil dipstick\*: See **Engine Oil Check** (page 139).

\* The filler caps and the engine oil dipstick are coloured for easy identification.

# Maintenance

## UNDER BONNET OVERVIEW - 1.4L DURATEC-16V (66KW/90PS)/1.6L DURATEC-16V TI-VCT (77KW/105PS) - SIGMA

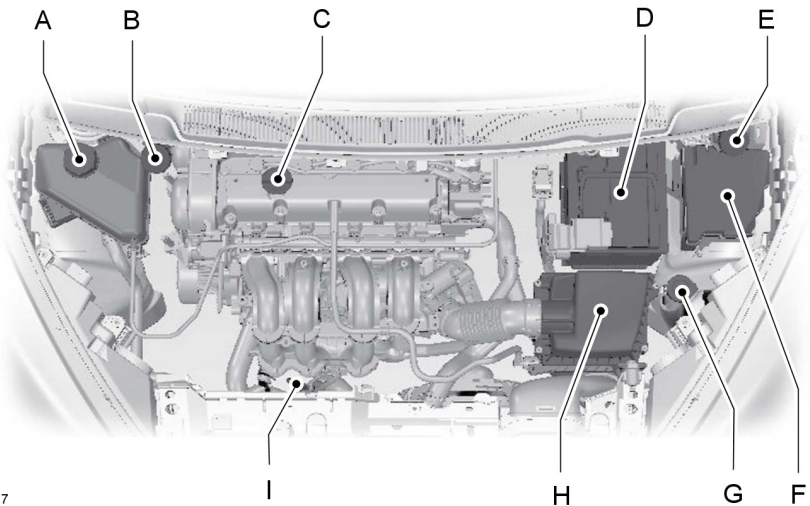

E141517

- A Engine coolant reservoir\*: See **Engine Coolant Check** (page 140).
- B Brake and clutch fluid reservoir (right-hand drive)\*: See **Brake and Clutch Fluid Check** (page 141).
- C Engine oil filler cap\*: See **Engine Oil Check** (page 139).
- D Battery: See **Changing the 12V Battery** (page 141).
- E Brake and clutch fluid reservoir (left-hand drive)\*: See **Brake and Clutch Fluid Check** (page 141).
- F Engine compartment fuse box. See **Fuses** (page 124).
- G Windscreen and rear window washer fluid reservoir: See **Washer Fluid Check** (page 141).
- H Air cleaner: No maintenance necessary.
- I Engine oil dipstick\*: See **Engine Oil Check** (page 139).

\* The filler caps and the engine oil dipstick are coloured for easy identification.

# Maintenance

## UNDER BONNET OVERVIEW - 1.5L DURATORQ-TDCI (55KW/75PS)/1.6L DURATORQ-TDCI (70KW/95PS) (T3)

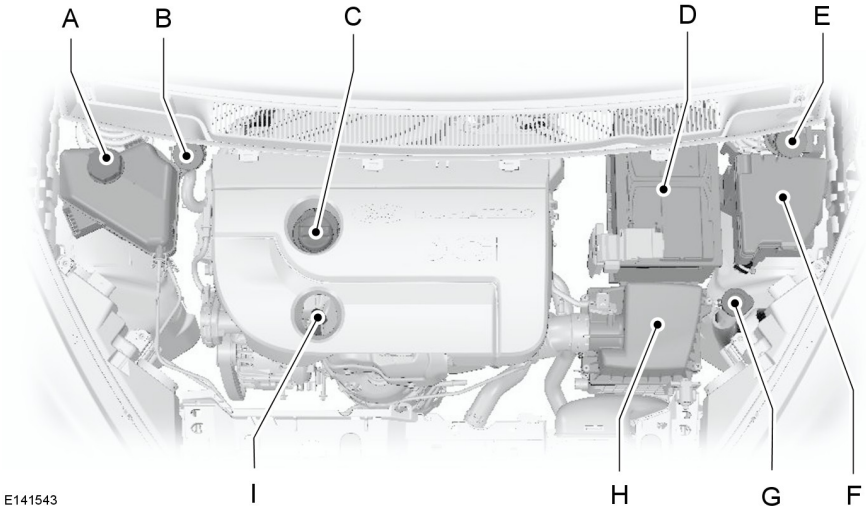

E141543

- A Engine coolant reservoir\*: See **Engine Coolant Check** (page 140).
- B Brake and clutch fluid reservoir (right-hand drive)\*: See **Brake and Clutch Fluid Check** (page 141).
- C Engine oil filler cap\*: See **Engine Oil Check** (page 139).
- D Battery: See **Changing the 12V Battery** (page 141).
- E Brake and clutch fluid reservoir (left-hand drive)\*: See **Brake and Clutch Fluid Check** (page 141).
- F Engine compartment fuse box. See **Fuses** (page 124).
- G Windscreen and rear window washer fluid reservoir: See **Washer Fluid Check** (page 141).
- H Air cleaner: No maintenance necessary.
- I Engine oil dipstick\*: See **Engine Oil Check** (page 139).

\* The filler caps and the engine oil dipstick are coloured for easy identification.

# Maintenance

## ENGINE OIL DIPSTICK - 1.0L ECOBOOST (74KW/100PS)/1.0L ECOBOOST (90KW/120PS)

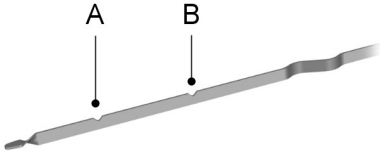

E141337

- A Minimum
- B Maximum

## ENGINE OIL DIPSTICK - 1.4L DURATEC-16V (66KW/90PS)/1.6L DURATEC-16V TI-VCT (77KW/105PS) - SIGMA

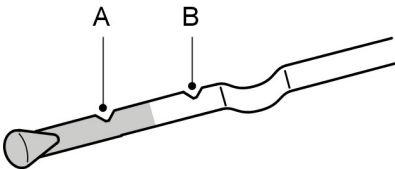

E95540

- A Minimum
- B Maximum

## ENGINE OIL DIPSTICK - 1.5L DURATORQ-TDCI (55KW/75PS)/1.6L DURATORQ-TDCI (70KW/95PS) (T3)

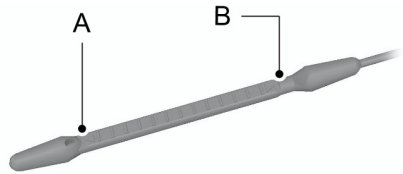

E140423

- A Minimum
- B Maximum

## ENGINE OIL CHECK

### WARNING



Do not use oil additives or other engine treatments. Under certain conditions, they could damage the engine.

**Note:** The oil consumption of new engines reaches its normal level after approximately 3000 miles (5000 kilometres).

### Checking the Oil Level

**Note:** Check the level before starting the engine.

**Note:** Make sure that the level is between the MIN and the MAX marks.

1. Make sure that your vehicle is on level ground.
2. Switch off the engine and wait 10 minutes for the oil to drain into the oil pan.

# Maintenance

3. Remove the dipstick and wipe it with a clean, lint free cloth. Replace the dipstick and remove it again to check the oil level.

If the level is at the MIN mark, top up immediately.

## Topping Up

### WARNINGS



Only top up when the engine is cold. If the engine is hot, wait 10 minutes for the engine to cool down.



Do not remove the filler cap when the engine is running.

Remove the filler cap.

### WARNING



Do not top up further than the MAX mark.

**Note:** Soak up any spillage with an absorbent cloth immediately.

Top up with fluid that meets the Ford specification. See **Technical Specifications** (page 150).

Replace the filler cap. Turn it until you feel a strong resistance.

## ENGINE COOLANT CHECK

### WARNING



Do not allow the fluid to touch your skin or eyes. If this happens, rinse the affected areas immediately with plenty of water and contact your doctor.

**Note:** Make sure that the level is between the **MIN** and the **MAX** marks.

**Note:** Coolant expands when it is hot. The level may therefore extend beyond the **MAX** mark.

If the level is at the **MIN** mark, add coolant immediately.

## Adding Engine Coolant

### WARNINGS



Only add coolant when the engine is cold. If the engine is hot, wait 10 minutes for the engine to cool down.



Do not remove the filler cap when the engine is running.



Do not remove the filler cap when the engine is hot. Wait for the engine to cool down.



Undiluted coolant is flammable and may ignite if spilt on a hot exhaust.

**Note:** In an emergency, you can add just water to the cooling system to reach a vehicle service station. Have the system checked by an authorised dealer as soon as possible.

**Note:** Prolonged use of incorrect dilution of the coolant can cause engine damage from corrosion, overheating or freezing.

**Note:** Do not add coolant further than the **MAX** mark.

1. Remove the filler cap. Any pressure will escape slowly as you unscrew the cap.
2. Add a 50/50 mixture of coolant and water using fluid that meets the Ford specifications. See **Technical Specifications** (page 150).
3. Replace the filler cap. Turn it until you feel a strong resistance.

# Maintenance

## BRAKE AND CLUTCH FLUID CHECK

### WARNINGS



Use of any fluid other than the recommended brake fluid may reduce brake efficiency and not meet Ford's performance standards.



Do not allow the fluid to touch your skin or eyes. If this happens, rinse the affected areas immediately with plenty of water and contact your doctor.



If the level is at the **MIN** mark, have the system checked by an authorised dealer as soon as possible.

**Note:** *Keep brake fluid clean and dry. Contamination with dirt, water, petroleum products or other materials may result in brake system damage and possible failure.*

**Note:** *The brake and the clutch systems are supplied from the same reservoir.*

Add fluid that meets the Ford specification. See **Technical Specifications** (page 150).

## WASHER FLUID CHECK

**Note:** *The reservoir supplies the front and rear washer systems.*

When adding fluid, use a mixture of washer fluid and water to help prevent freezing in cold weather and improve the cleaning capability. We recommend that you use only high quality washer fluid.

For information on fluid dilution, refer to the product instructions.

## CHANGING THE 12V BATTERY

### WARNING



For vehicles with start-stop the battery requirement is different. You must replace the battery with one of exactly the same specification.

**Note:** *Where applicable you must reprogram the audio system using the keycode.*

The battery is located in the engine compartment. See **Maintenance** (page 134).

## CHECKING THE WIPER BLADES



E142463

Run the tip of your fingers over the edge of the blade to check for roughness.

Clean the wiper blades with washer fluid or water applied with a soft sponge or cloth.

## CHANGING THE WIPER BLADES

### Windscreen Wiper Blades

**Note:** *The windscreen wiper blades are different in length. See **Technical Specifications** (page 150). If you install wiper blades of the wrong length, the rain sensor may not work correctly.*

# Maintenance

## Changing the Windscreen Wiper Blades

**Note:** Make sure that the wiper blade locks into place.

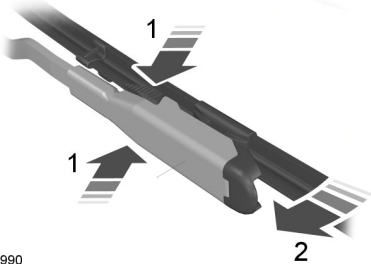

E129990

1. Press the locking buttons together.
2. Rotate and remove the wiper blade.
3. Install in the reverse order.

**Note:** Make sure that the wiper blade locks into place.

## Rear Window Wiper Blade

1. Lift the wiper arm.

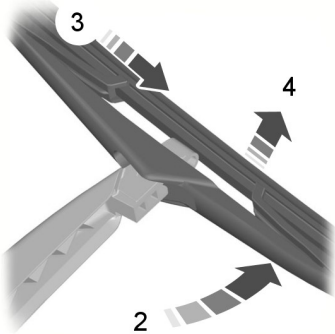

E86456

2. Position the wiper blade at right angles to the wiper arm.
3. Disengage the wiper blade from the wiper arm.
4. Remove the wiper blade.
5. Install in the reverse order.

## REMOVING A HEADLAMP

1. Open the bonnet. See **Opening and Closing the Bonnet** (page 134).

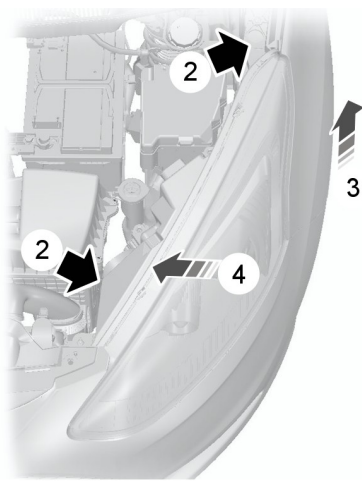

E144433

2. Remove the screws and push pins.
3. Lift the outer side of the headlamp to disengage it from the lower fixing point.
4. Pull the headlamp as far as possible toward the centre of your vehicle and remove.



# Maintenance

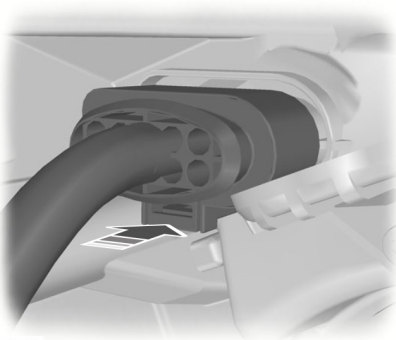

E88875

5. Disconnect the electrical connector.

**Note:** When fitting the headlamp, make sure that you reconnect the electrical connector correctly.

**Note:** When fitting the headlamp, make sure that you fully engage the headlamp in the lower fixing point.

## CHANGING A BULB

### WARNINGS



Switch the lamps and the ignition off.



Let the bulb cool down before removing it.



Do not touch the glass of the bulb.

**Note:** Only fit bulbs of the correct specification.

**Note:** The following instructions describe how to remove the bulbs. Fit replacements in the reverse order unless otherwise stated.

### Headlamp

**Note:** Remove the covers to gain access to the bulbs.

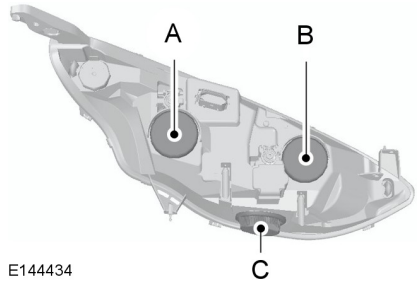

E144434

- A Headlamp main beam
- B Headlamp dipped beam
- C Direction indicator

### Direction Indicator

1. Remove the headlamp. See **Removing a Headlamp** (page 142).

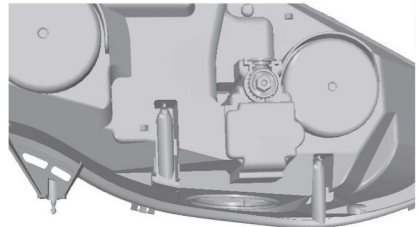

E144435

2. Turn the bulb holder anticlockwise and remove it.

# Maintenance

3. Gently press the bulb into the bulb holder, turn it anticlockwise and remove it.

## Headlamp Main Beam

1. Remove the headlamp. See **Removing a Headlamp** (page 142).

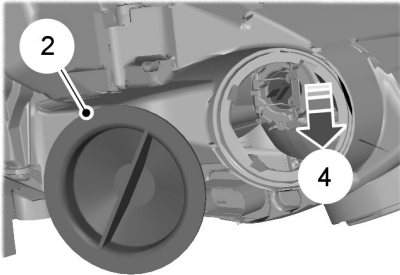

E130175

2. Remove the cover.
3. Disconnect the electrical connector.
4. Release the clip and remove the bulb.

**Note:** Do not touch the glass of the bulb.

## Headlamp Dipped Beam

1. Remove the headlamp. See **Removing a Headlamp** (page 142).

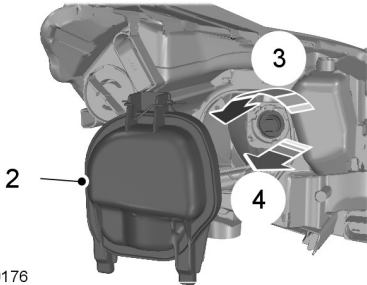

E130176

2. Remove the cover.

3. Turn the bulb holder anticlockwise and remove it.
4. Remove the bulb.

**Note:** Do not touch the glass of the bulb.

## Side Lamp

1. Remove the headlamp. See **Removing a Headlamp** (page 142).

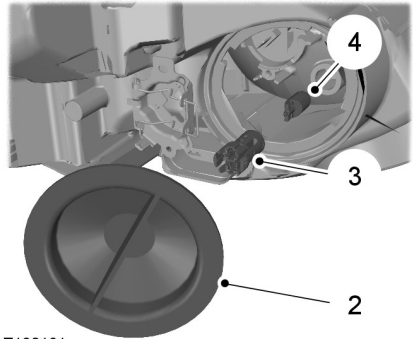

E130181

2. Remove the cover.
3. Remove the bulb holder.
4. Remove the bulb.

## Side Repeater



E72263

# Maintenance

1. Carefully remove the side repeater.

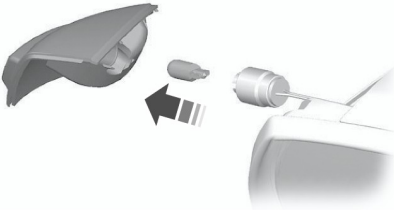

E72291

2. Remove the bulb holder.
3. Remove the bulb.

## Approach Lamp

**Note:** Position the mirror glass as far inward as possible.

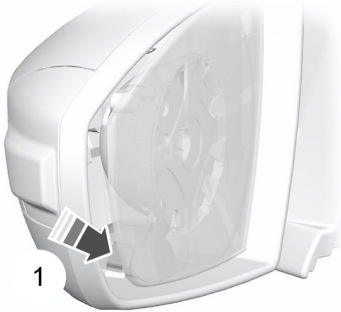

E72264

1. Insert a screwdriver into the gap between the mirror housing and the mirror glass and release the metal retaining clip.

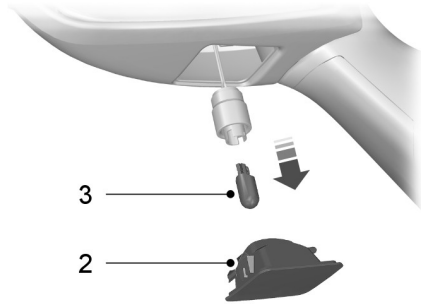

E72265

2. Remove the lamp.
3. Remove the bulb.

## Front Fog Lamps

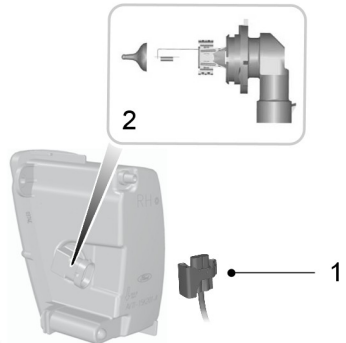

E145926

**Note:** You cannot separate the fog lamp bulb from the bulb holder.

1. Disconnect the electrical connector.
2. Turn the bulb holder anticlockwise and remove it.

# Maintenance

## Rear Lamps

### Direction Indicator, Rear and Brake Lamp

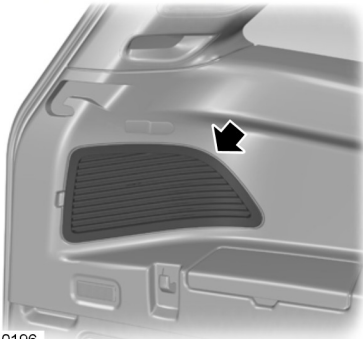

E130196

1. Remove the trim panel.

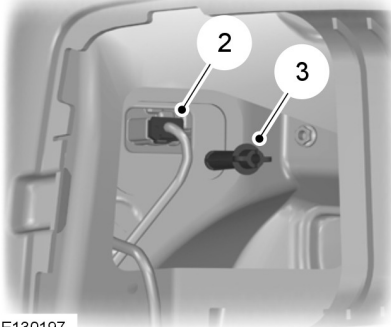

E130197

2. Disconnect the electrical connector.
3. Remove the wing nut.
4. Remove the lamp.

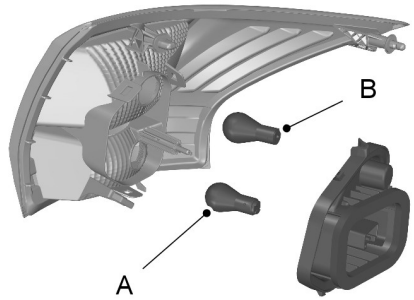

E130198

5. Remove the bulb holder.
  6. Gently press the bulb into the bulb holder, turn it anticlockwise and remove it.
- A. Rear and brake lamp  
B. Direction indicator

### Reversing Lamp and Fog Lamp



E130199

1. Open the liftgate.
2. Remove the trim panel.

# Maintenance

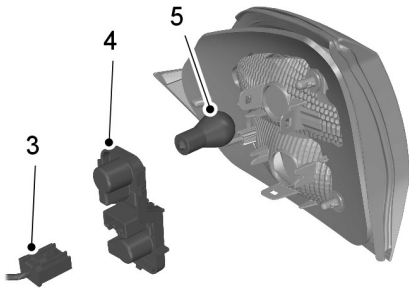

E146083

3. Disconnect the electrical connector.
4. Turn the bulb holder anticlockwise and remove it.
5. Gently press the bulb into the bulb holder, turn it anticlockwise and remove it.

## Central High Mounted Brake Lamp



E87619

1. Open the liftgate.
2. Detach the clips.

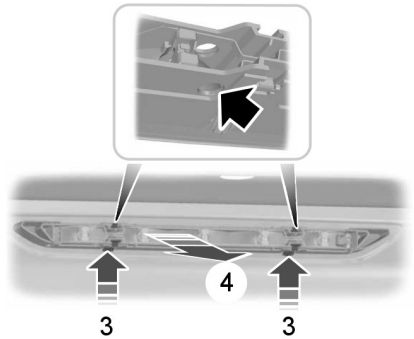

E146084

3. Insert a suitable object into the holes.
4. Carefully pull the lamp toward the front of the vehicle to release the spring clips.



E146085

5. Remove the lamp.

# Maintenance

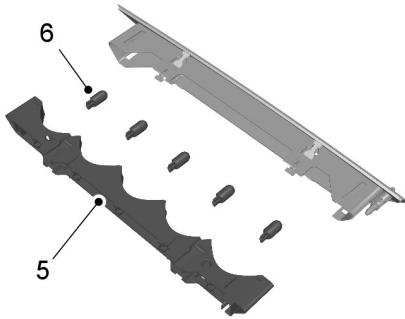

E130205

6. Remove the bulb holder.
7. Remove the bulb.

## Licence Plate Lamp

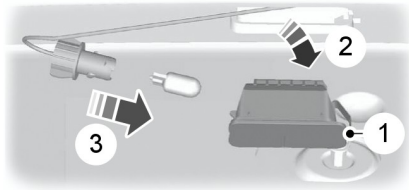

E72789

1. Carefully release the spring clip.
2. Remove the lamp.
3. Remove the bulb.

## Interior Lamp

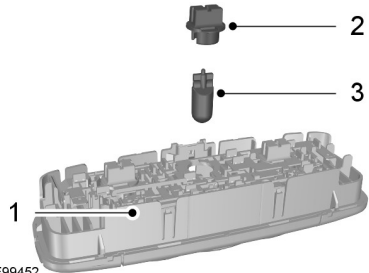

E99452

1. Carefully remove the lamp.
2. Turn the bulb holder anticlockwise and remove it.
3. Remove the bulb.

## Reading Lamps

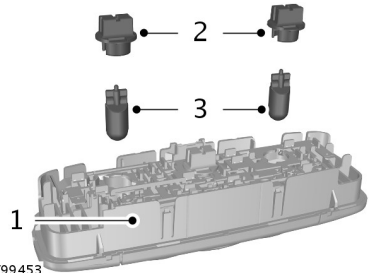

E99453

1. Carefully remove the lamp.
2. Turn the bulb holder anticlockwise and remove it.
3. Remove the bulb.

# Maintenance

## Luggage Compartment Lamp, Footwell Lamp and Liftgate Lamp

1. Carefully prise out the lamp.
2. Remove the bulb.

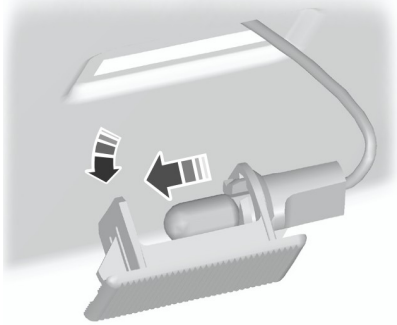

E72784

## BULB SPECIFICATION CHART

Lamp	Specification	Power (watt)
Front direction indicator	PY21W	21
Headlamp main beam - high series	H1	55
Headlamp main beam - low series	H15	55
Headlamp dipped beam	H7	55 <sup>1</sup>
Front fog lamp	H11	55
Side lamp - low series	W5W	5
Side repeater	WY5W	5
Approach lamp	W5W	5
Rear direction indicator	PY21W	21
Brake and rear lamp	P21/5W	21/5
Rear fog lamp	H21W	21
Reversing lamp	P21W	21

# Maintenance

Lamp	Specification	Power (watt)
Licence plate lamp	W5W	5
Luggage compartment lamp	W5W	5

<sup>1</sup>Fit a replacement with the same rating as the one you have removed.

**Note:** *On some vehicles the lamps are LED. These are not serviceable items, see an authorised dealer if they fail.*

## TECHNICAL SPECIFICATIONS

### Vehicle Fluids

**Note:** *Use fluids which meet the specifications or requirements defined. Use of other fluids may lead to damage which is not covered by your warranty.*

Item	Specification	Viscosity Grade	Recommended fluid
Engine oil - petrol engines only	WSS-M2C948-B	5W-20	Castrol or Ford Engine Oil
Alternative engine oil - all petrol engines except 1.0L EcoBoost	WSS-M2C913-C	5W-30	Castrol or Ford Engine Oil
Engine oil - diesel engines	WSS-M2C913-C	5W-30	Castrol or Ford Engine Oil
Antifreeze	WSS-M97B44-D	-	Motorcraft SuperPlus Antifreeze
Brake fluid	WSS-M6C65-A2 or ISO 4925 Class 6	-	Motorcraft or Ford DOT 4 LV High Performance Brake Fluid

Your engine has been designed to be used with Castrol and Ford Engine Oil, which gives a fuel economy benefit while maintaining the durability of your engine.

**Adding oil:** If you are unable to find an oil that meets the specification defined by WSS-M2C913-C or WSS-M2C948-B (petrol engines only), you must use SAE 5W-30 that meets the specification defined by ACEA A5/B5.

Using oils other than the one specified can result in longer engine cranking periods, reduced engine performance, reduced fuel economy and increased emission levels.

Castrol engine oil recommended.



## Maintenance



<b>Variant</b>	<b>Item</b>	<b>Capacity in gallons (litres)</b>
All	Windscreen and rear window washer system	0.6 (2.5)
1.0L EcoBoost	Engine cooling system	approximately 1.4 (6.3)
Vehicles with a petrol engine except 1.0L EcoBoost	Engine cooling system	approximately 1.2 (5.5)
Vehicles with a diesel engine	Engine cooling system	approximately 1.3 (6)
Vehicles with a petrol engine	Fuel tank	10.6 (48)
Vehicles with a diesel engine	Fuel tank	10.3 (47)
1.0L EcoBoost	Engine lubrication system - including the oil filter	0.9 (4.1)
1.0L EcoBoost	Engine lubrication system - excluding the oil filter	0.9 (4.0)
1.4L Duratec-16V	Engine lubrication system - including the oil filter	0.9 (4.1)
1.4L Duratec-16V	Engine lubrication system - excluding the oil filter	0.8 (3.8)
1.6L Duratec-16V Ti-VCT	Engine lubrication system - including the oil filter	0.9 (4.1)
1.6L Duratec-16V Ti-VCT	Engine lubrication system - excluding the oil filter	0.8 (3.8)

# Maintenance

<b>Variant</b>	<b>Item</b>	<b>Capacity in gallons (litres)</b>
1.5L Duratorq-TDCi	Engine lubrication system - including the oil filter	0.8 (3.8)
1.5L Duratorq-TDCi	Engine lubrication system - excluding the oil filter	0.8 (3.4)
1.6L Duratorq-TDCi	Engine lubrication system - including the oil filter	0.8 (3.8)
1.6L Duratorq-TDCi	Engine lubrication system - excluding the oil filter	0.8 (3.5)

## Engine Oil Adding Capacities





<b>Engine</b>	<b>Capacity in gallons (litres)</b>
1.0L EcoBoost	0.2 (0.8)
1.4L Duratec-16V and 1.6L Duratec-16V Ti-VCT	0.2 (0.8)
1.5L Duratorq-TDCi	0.4 (1.6)
1.6L Duratorq-TDCi	0.4 (1.6)

# Vehicle Care

---

## CLEANING THE EXTERIOR



### WARNINGS

-  If you use a car wash with a waxing cycle, make sure that you remove the wax from the windscreen.
  -  Prior to using a car wash facility check the suitability of it for your vehicle.
  -  Some car wash installations use water at high pressure. This could damage certain parts of your vehicle.
  -  Remove the aerial before using an automatic car wash.
  -  Switch the heater blower off to prevent contamination of the fresh air filter.
- 

We recommend that you wash your vehicle with a sponge and lukewarm water containing a car shampoo.

## Cleaning the Headlamps

### WARNINGS

-  Do not scrape the headlamp lenses or use abrasives, alcoholic solvents or chemical solvents to clean them.
  -  Do not wipe the headlamps when they are dry.
- 

## Cleaning the Rear Window



### WARNING

-  Do not scrape the inside of the rear window or use abrasives or chemical solvents to clean it.
- 

Use a clean, lint free cloth or a damp chamois leather to clean the inside of the rear window.



## Cleaning the Chrome Trim

### WARNINGS

-  Do not use abrasives or chemical solvents. Use soapy water.
  -  Do not apply cleaning product to hot surfaces and do not leave cleaning product on chrome surfaces for a period of time exceeding that which is recommended.
  -  Industrial-strength (heavy-duty) cleaners, or cleaning chemicals, may cause damage over a period of time.
- 

## Body Paintwork Preservation

### WARNINGS



-  Do not polish your vehicle in strong sunshine.
  -  Do not allow polish to touch plastic surfaces. It could be difficult to remove.
  -  Do not apply polish to the windscreen or rear window. This could cause the wipers to become noisy and they may not clear the window properly.
- 

We recommend that you wax the paintwork once or twice a year.

## CLEANING THE INTERIOR

### Seat Belts

### WARNINGS

-  Do not use abrasives, or chemical solvents to clean them.
  -  Do not allow moisture to penetrate the seat belt retractor mechanism.
-

# Vehicle Care

---

Clean the seat belts with interior cleaner or water applied with a soft sponge. Let the seat belts dry naturally, away from artificial heat.

## Instrument Cluster Screens, LCD Screens and Radio Screens

### WARNING



Do not use abrasives, alcoholic solvents or chemical solvents to clean them.

## Rear Windows

### WARNING



Do not use any abrasive materials to clean the interior of the rear windows.

**Note:** Do not install stickers or labels to the interior of the rear windows.

## REPAIRING MINOR PAINT DAMAGE

You should repair paintwork damage caused by stones from the road or minor scratches as soon as possible. A choice of products are available from an authorised dealer.

Remove particles such as bird droppings, tree sap, insect deposits, tar spots, road salt and industrial fallout before repairing paint chips.

Always read and follow the manufacturer's instructions before using the products.

## CLEANING THE ALLOY WHEELS

**Note:** Do not apply a cleaning chemical to warm or hot wheel rims and covers.

**Note:** Industrial-strength (heavy-duty) cleaners, or cleaning chemicals, in combination with brush agitation to remove brake dust and dirt, could wear away the clear coat finish over a period time.

**Note:** Do not use hydrofluoric acid-based or high caustic-based wheel cleaners, steel wool, fuels or strong household detergent.

**Note:** If you intend parking your vehicle for an extended period after cleaning the wheels with a wheel cleaner, drive your vehicle for a few minutes before doing so. This will reduce the risk of increased corrosion of the brake discs, brake pads and linings.

**Note:** Some automatic car washes may cause damage to the finish on your wheel rims and covers.

Alloy wheels and wheel covers are coated with a clear coat paint finish. To maintain their condition we recommend that you:

- Clean them weekly with the recommended wheel and tyre cleaner.
- Use a sponge to remove heavy deposits of dirt and brake dust accumulation.
- Rinse them thoroughly with a pressurised stream of water when you have completed the cleaning process.

We recommend that you use Ford service wheel cleaner. Make sure that you read and follow the manufacturer's instructions.

Using other non-recommended cleaning products can result in severe and permanent cosmetic damage.

# Wheels and Tyres

## GENERAL INFORMATION

A decal with tyre pressure data is located in the driver's door opening.

Check and set the tyre pressure at the ambient temperature in which you are intending to drive your vehicle and when the tyres are cold.

**Note:** Check your tyre pressures regularly to optimise fuel economy.

**Note:** Use only approved wheel and tyre sizes. Using other sizes could damage your vehicle and will make the National Type Approval invalid.

**Note:** If you change the diameter of the tyres from that fitted at the factory, the speedometer may not display the correct speed. Take your vehicle to an authorised dealer to have the engine management system reprogrammed.

**Note:** If you intend to change the size of the wheels from that fitted at the factory, check the suitability with an authorised dealer.

## TEMPORARY MOBILITY KIT

Your vehicle may not have a spare tyre. Therefore you will have an emergency kit which will only repair one flat tyre.

The kit is located in the spare wheel well.

### General Information

#### WARNINGS

 Depending on the type and extent of tyre damage, some tyres can only be partially sealed or not sealed at all.

Loss of tyre pressure can affect vehicle handling, leading to loss of vehicle control.

 Do not use the kit on a previously damaged tyre, for example when it has been driven under inflated.

#### WARNINGS

 Do not use the kit on run flat tyre.

 Do not try to seal damage other than that located within the visible tread of the tyre.

 Do not try to seal damage to the tyre's sidewall.

The kit seals most tyre punctures [with a diameter of up to 1/4 inch (six millimetres)] to temporarily restore mobility.

Observe the following rules when using the kit:

- Drive with caution and avoid making sudden steering or driving manoeuvres, especially if your vehicle is heavily loaded or you are towing a trailer.
- The kit will provide you with an emergency temporary repair, enabling you to continue your journey to the next vehicle or tyre dealer, or to drive a maximum distance of 125 miles (200 kilometres).
- Do not exceed a maximum speed of 50 mph (80 km/h).
- Keep the kit out of the reach of children.
- Only use the kit when the ambient temperature is between  $-22^{\circ}\text{F}$  ( $-30^{\circ}\text{C}$ ) and  $+158^{\circ}\text{F}$  ( $+70^{\circ}\text{C}$ ).

### Using the Kit

#### WARNINGS

 Compressed air can act as an explosive or propellant.

 Never leave the kit unattended while in use.

 Do not keep the compressor operating for more than 10 minutes.

# Wheels and Tyres

**Note:** Use the kit only for the vehicle with which it was supplied.

- Park your vehicle at the roadside so that you do not obstruct the flow of traffic and so that you are able to use the kit without being in danger.
- Apply the parking brake, even if you have parked on a level road, to make sure that your vehicle will not move.
- Do not attempt to remove foreign objects like nails or screws penetrating the tyre.
- Leave the engine running while the kit is in use, but not if your vehicle is in an enclosed or poorly ventilated area (for example, inside a building). In these circumstances, switch the compressor on with the engine turned off.
- You must replace the sealant bottle with a new one before the expiry date (see top of bottle).
- Inform all other users of your vehicle that the tyre has been temporarily sealed with the kit. Make them aware of the special driving conditions to be observed.

## Inflating the Tyre

### WARNINGS

- ⚠ Check the sidewall of the tyre prior to inflation. If there are any cracks, bumps or similar damage, do not attempt to inflate the tyre.
- ⚠ Do not stand directly beside the tyre while the compressor is pumping.
- ⚠ Watch the sidewall of the tyre. If any cracks, bumps or similar damage appear, turn off the compressor and let the air out by means of the pressure relief valve I. Do not continue driving with this tyre.

### WARNINGS

- ⚠ The sealant contains natural rubber latex. Avoid contact with skin and clothing. If this happens, rinse the affected areas immediately with plenty of water. Consult a doctor if you experience an adverse reaction.
- ⚠ If the tyre inflation pressure does not reach 26 psi (1.8 bar) within 10 minutes, the tyre may have suffered excessive damage, making a temporary repair impossible. In this case, do not continue driving with this tyre.

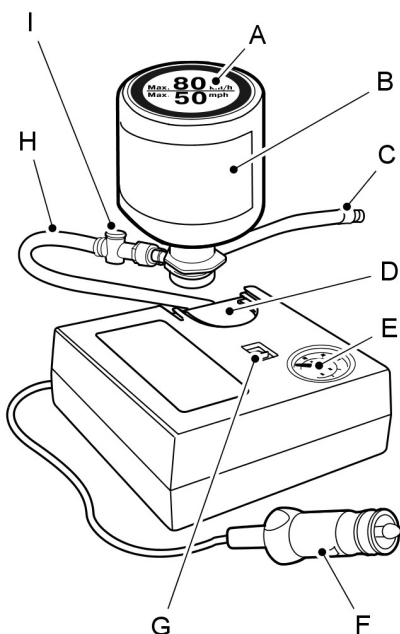

E102881

- A Label
- B Sealant bottle

## Wheels and Tyres

---

- C Sealant bottle hose
- D Bottle holder
- E Pressure gauge
- F Power plug with cable
- G Compressor switch
- H Repair kit hose
- I Pressure relief valve

1. Remove the kit from the wrapping.
2. Peel off the label A showing the maximum permissible speed of 50 mph (80 km/h) from the sealant bottle and attach it to the instrument panel in the driver's field of view. Make sure the label does not obscure anything important.
3. Take the hose H with the pressure relief valve I and the power plug with cable F out of the kit.
4. Connect the hose H with the pressure relief valve I to the sealant bottle B.
5. Engage the sealant bottle B into the bottle holder D.
6. Remove the valve cap from the damaged tyre.
7. Screw the sealant bottle hose C firmly onto the valve of the damaged tyre.
8. Make sure that the compressor switch G is in position O.
9. Insert the power plug F into the cigar lighter socket or auxiliary power socket. See **Cigar Lighter** (page 81). See **Auxiliary Power Points** (page 81).
10. Start the engine.
11. Move the compressor switch G to position 1.

12. Inflate the tyre for no longer than 10 minutes to an inflation pressure of minimum 26 psi (1.8 bar) and a maximum of 51 psi (3.5 bar). Move the compressor switch G to position O and check the current tyre pressure with pressure gauge E.

**Note:** *If a tyre pressure of 26 psi (1.8 bar) is not reached do not continue.*

**Note:** *When pumping in the sealant through the tyre valve, the pressure may rise up to 87psi (6 bar) but will drop again after about 30 seconds.*

13. Remove the power plug F from the cigar lighter socket or auxiliary power socket.
14. Quickly unscrew the hose C from the tyre valve. Fasten the valve cap again.
15. Leave the sealant bottle B in the bottle holder D.
16. Make sure the kit is stored safely, but still easily accessible in your vehicle. The kit will be required again when you check the tyre pressure.
17. Immediately drive approximately two miles (three kilometres) so that the sealant can seal the damaged area.

### WARNING



If you experience heavy vibrations, unsteady steering behavior or noises while driving, reduce your speed and drive with caution to a place where it is safe for you to stop your vehicle. Recheck the tyre and its pressure. If the tyre pressure is less than 14.7 psi (1 bar) or if there are any cracks, bumps or similar damage visible, do not continue driving with this tyre.

---

# Wheels and Tyres

18. Stop your vehicle after driving approximately two miles (three kilometres). Check, and where necessary, adjust the pressure of the damaged tyre.
19. Attach the kit and read the tyre pressure from the pressure gauge E.
20. Adjust it to the specified pressure. See **Technical Specifications** (page 164).
21. Once you have inflated the tyre to its correct tyre pressure, move the compressor switch G to position 0, remove the power plug F from the socket, unscrew the hose C and fasten the valve cap.
22. Leave hose C and H connected to the sealant bottle B and store the kit away safely.
23. Go to the nearest tyre specialist to get the damaged tyre replaced. Before the tyre is removed from the rim, inform your tyre dealer that the tyre contains sealant. You must renew the sealant bottle B and hose C as soon as possible once used.

**Note:** Remember that emergency roadside kits only provide temporary mobility. Regulations concerning tyre repair after usage of the kit may differ from country to country. You should consult a tyre specialist for advice.

## WARNING



You must, make sure the tyre is adjusted to the recommended inflation pressure. See **Technical Specifications** (page 164). You must, monitor the tyre pressure until the sealed tyre is replaced.

Empty sealant bottles can be disposed of together with normal household waste. Return remains of sealant to your dealer or dispose of it in compliance with local waste disposal regulations.

## TYRE CARE



E70415

To make sure the front and rear tyres of your vehicle wear evenly and last longer, we recommend that you swap the tyres from front to rear and vice versa at regular intervals of between 3000 and 6000 miles (5000 and 10000 kilometres).

## WARNING



Do not scrub the sidewalls of the tyres when you are parking.

If you have to mount a kerb, do so slowly and approach it with the wheels at right-angles to the curb.

Examine the tyres regularly for cuts, foreign objects and uneven wear of the tread. Uneven wear could mean that the wheel alignment is outside specification.

Check the tyre pressures (including the spare) when cold, every two weeks.



# Wheels and Tyres

## USING WINTER TYRES

### WARNING

 When using winter tyres on your vehicle, you must make sure that you fit the correct type of wheel nuts.

If winter tyres are used, make sure that the tyre pressures are correct. See **Technical Specifications** (page 164).

## USING SNOW CHAINS

### WARNINGS

 Do not exceed 30 mph (50 km/h).

 Do not use snow chains on snow-free roads.

 Only fit snow chains to specified tyres. See **Technical Specifications** (page 164).

 If your vehicle has wheel trims, remove them before fitting snow chains.

**Note:** *The anti-lock braking system will continue to operate normally.*

Only use small link snow chains.

Only use snow chains on the front wheels.

## Vehicles With Stability Control

When stability control is on, your vehicle may exhibit some unusual driving characteristics. To reduce this, switch traction control off. See **Using Stability Control** (page 103).

## TYRE PRESSURE MONITORING SYSTEM

### WARNINGS

 The system does not relieve you of your responsibility to regularly check the tyre pressures.

 The system will only provide a low tyre pressure warning. It will not inflate the tyres.

 Do not drive on significantly under-inflated tyres. This may cause the tyres to overheat and fail.

Under-inflation reduces fuel efficiency, tyre tread life and may also affect your ability to drive your vehicle safely.

 Do not bend or damage the valves when you are inflating the tyres.

 Have tyres installed by an authorised dealer.

The deflation detection system will alert you if there is a change of air pressure in any tyre. It does this by using the anti-lock braking sensors to detect the rolling circumference of the wheels. When the circumference changes, this indicates low tyre pressure. A warning message is displayed in the information display and the message indicator will illuminate. See **Information Messages** (page 62).

If a low pressure warning message is displayed in the information display, check the tyre pressures as soon as possible and inflate them to the recommended pressure. See **Technical Specifications** (page 164).

If this happens frequently, have the cause determined and rectified as soon as possible.

# Wheels and Tyres

---

Apart from a too low tyre pressure or a damaged tyre, the following situations can affect the rolling circumference:

- Vehicle load is uneven.
- When using a trailer or travelling up and down an incline.
- Using snow chains.
- Driving on soft surfaces such as snow or mud.

**Note:** *The system will still function correctly, but there may be an increased detection time.*

## System Reset

**Note:** *Do not reset the system when your vehicle is moving.*

**Note:** *You should reset the system following any adjustment to the tyre pressures or any changing of tyres.*

1. Switch the ignition on.
2. Using the information display control, navigate to **Menu > Vehicle settings > Deflation detection**.
3. Press and hold the **OK** button until confirmation appears.

## CHANGING A ROAD WHEEL

### Wheel Nuts

You can obtain a replacement locking wheel nut key and replacement locking wheel nuts from your dealer using the reference number certificate.

### Vehicles With a Spare Wheel

If the spare wheel is exactly the same type and size as the other fitted road wheels, you can replace the existing road wheel with the spare wheel and continue to drive in the normal manner.

If the spare wheel is different to the other road wheels, it will carry a yellow label with the appropriate speed limit.

Refer to the following information before changing the road wheel.

### WARNINGS



Drive the shortest possible distances.



Do not fit more than one spare wheel on your vehicle at any one time.



Do not carry out any tyre repairs on a spare wheel.



Do not drive through an automatic car wash.



If you are unsure what type of spare wheel you have do not exceed 80 km/h (50 mph).



Only fit snow chains to specified tyres. See **Technical Specifications** (page 164).



The ground clearance of your vehicle may be reduced. Take care when parking next to a kerb.

---

**Note:** *Your vehicle may exhibit some unusual driving characteristics.*

### Vehicle Jack

### WARNINGS



The vehicle jack supplied with your vehicle should only be used when changing a wheel in emergency situations.



Before using the vehicle jack, check that it is not damaged or deformed and that the thread is lubricated and free from foreign matter.



Never place anything between the jack and the ground, or the jack and your vehicle.

---

# Wheels and Tyres

**Note:** Vehicles with a temporary mobility kit do not have a vehicle jack or a wheel brace.

It is recommended to use a workshop type hydraulic jack for changing between summer and winter tyres.

**Note:** Use a jack with a minimum lifting capacity of 1.5 tonnes and a lifting plate with a minimum diameter of 3.1 inches (80 millimetres).

## Vehicles With a Spare Wheel

Your vehicle jack, wheel brace, screw-in towing eye and wheel trim remover are located in the spare wheel well.

## Jacking and Lifting Points

### WARNING



Use only the specified jacking points. If you use other positions, you may damage the body, steering, suspension, engine, braking system or the fuel lines.

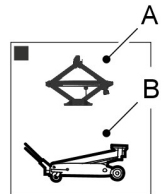
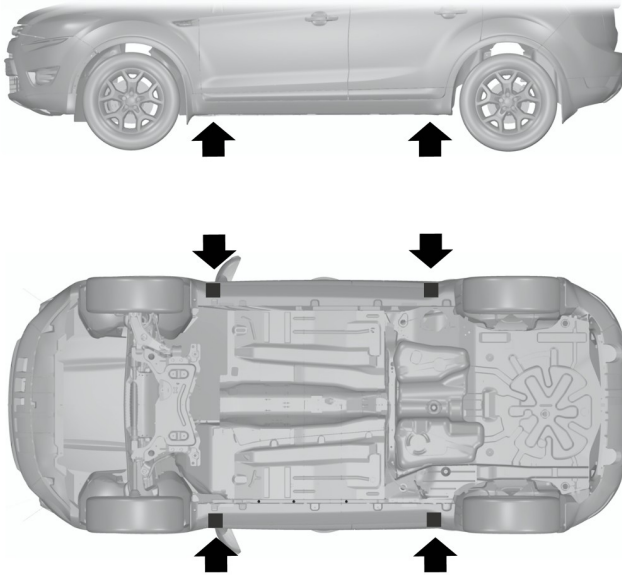

E92658

- A Emergency use only
- B Maintenance

# Wheels and Tyres

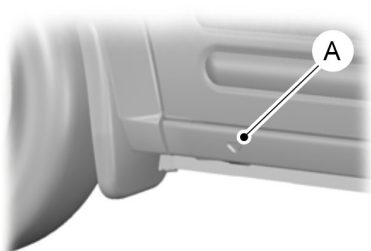

E93302

- A Small arrow-shaped marks on the sills show the location of the jacking points.

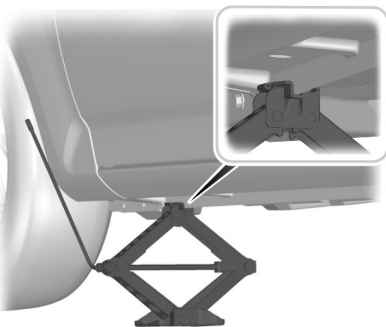

E92932

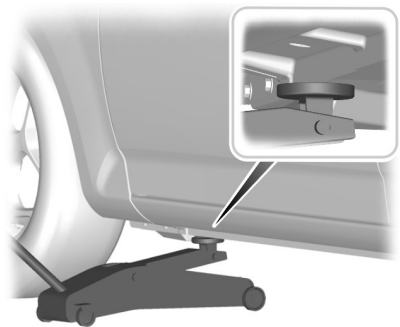

E93020

## Assembling the Wheel Brace

### WARNING

-  The screw-in towing eye has a left-hand thread. Turn it anticlockwise to install it. Make sure that the towing eye is fully tightened.

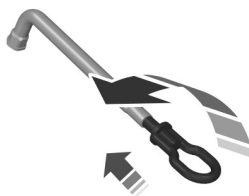

E122502

Insert the screw-in towing eye into the wheel brace.

## Removing the Wheel Trim

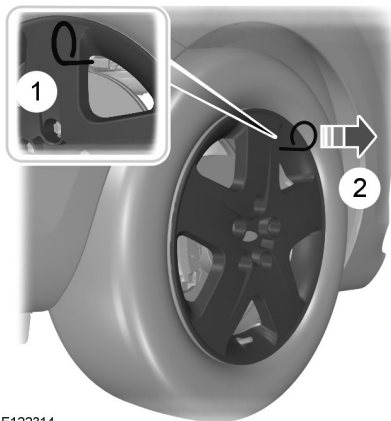

E122314

1. Insert the wheel trim remover.
2. Remove the wheel trim.

# Wheels and Tyres

**Note:** Make sure that you pull the wheel trim remover at right angles to the trim.

## Removing a Road Wheel

### WARNINGS

 Park your vehicle in such a position that neither the traffic nor you are hindered or endangered.

 Set up a warning triangle.

 Make sure that your vehicle is on firm, level ground with the wheels pointing straight ahead.

 Switch the ignition off and apply the parking brake.

 If your vehicle has a manual transmission, move the selector lever to first or reverse gear. If it has an automatic transmission, move the selector lever to position **(P)**.

 Have the passengers leave your vehicle.

 Secure the diagonally opposite wheel with an appropriate block or wheel chock.

 Make sure that the arrows on directional tyres point in the direction of rotation when your vehicle is moving forward. If you have to fit a spare wheel with the arrows pointing in the opposite direction, have the tyre refitted in the correct direction by an authorised dealer.

 Do not work underneath your vehicle when it is supported only by a jack.

 Make sure that the jack is vertical to the jacking point and the base is flat on the ground.

**Note:** Do not lay alloy wheels face down on the ground, this will damage the paint.

**Note:** The spare wheel is located under the floor cover in the luggage compartment.

1. Install the locking wheel nut key.

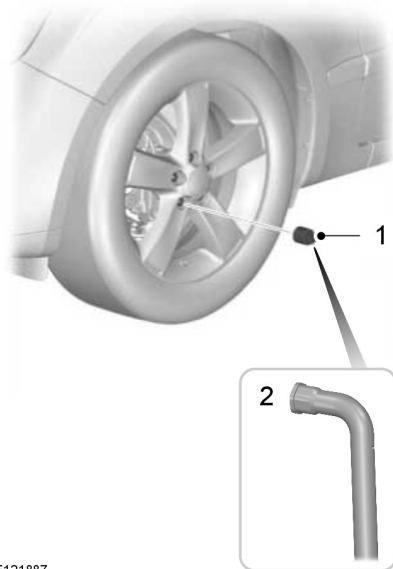

E121887

2. Slacken the wheel nuts.
3. Jack up your vehicle until the tyre is clear of the ground.
4. Remove the wheel nuts and the wheel.

## Installing a Road Wheel

### WARNINGS

 Use only approved wheel and tyre sizes. Using other sizes could damage your vehicle and will make the National Type Approval invalid. See **Technical Specifications** (page 164).

 Do not fit run flat tyres on vehicles that were not originally fitted with them. Contact an authorised dealer for more details about compatibility.

# Wheels and Tyres

## WARNING



Do not install alloy wheels using wheel nuts designed for use with steel wheels.

**Note:** *The wheel nuts of alloy wheels and spoked steel wheels can also be used for the steel spare wheel for a short time (maximum two weeks).*

**Note:** *Make sure the wheel and hub contact surfaces are free from foreign matter.*

**Note:** *Make sure that the cones on the wheel nuts are against the wheel.*

1. Install the wheel.
2. Install the wheel nuts finger tight.
3. Install the locking wheel nut key.

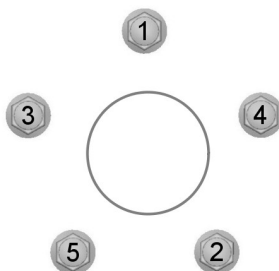

E75442

4. Partially tighten the wheel nuts in the sequence shown.
5. Lower your vehicle and remove the jack.
6. Fully tighten the wheel nuts in the sequence shown. See **Technical Specifications** (page 164).
7. Install the wheel trim using the ball of your hand.

## WARNING



Have the wheel nuts checked for tightness and the tyre pressure checked as soon as possible.

## TECHNICAL SPECIFICATIONS

### Wheel Nut Torque

Wheel type	lb-ft (Nm)
All	100 (135)

# Wheels and Tyres

## Tyre Pressures (Cold Tyres)

### Up to 50 mph (80 km/h)

Variant	Tyre size	Normal load		Full load	
		Front	Rear	Front	Rear
		lbf/in <sup>2</sup> (bar)	lbf/in <sup>2</sup> (bar)	lbf/in <sup>2</sup> (bar)	lbf/in <sup>2</sup> (bar)
Temporary spare wheel when it differs from the other fitted wheels	125/80 R15	61 (4.2)	61 (4.2)	61 (4.2)	61 (4.2)

### Up to 100mph (160 km/h)

Variant	Tyre size	Normal load		Full load	
		Front	Rear	Front	Rear
		lbf/in <sup>2</sup> (bar)	lbf/in <sup>2</sup> (bar)	lbf/in <sup>2</sup> (bar)	lbf/in <sup>2</sup> (bar)
All engines	185/60 R15*	33 (2.3)	29 (2)	36 (2.5)	41 (2.8)
All engines	195/60 R15	32 (2.2)	29 (2)	36 (2.5)	46 (3.2)
All engines	195/55 R16	32 (2.2)	29 (2)	36 (2.5)	41 (2.8)
All engines	205/45 R17	33 (2.3)	29 (2)	36 (2.5)	41 (2.8)

\*Only fit snow chains to specified tyres.

## Wheels and Tyres

---

### Continuous Speed in Excess of 100mph (160 km/h)

Variant	Tyre size	Normal load		Full load	
		Front	Rear	Front	Rear
		lbf/in <sup>2</sup> (bar)	lbf/in <sup>2</sup> (bar)	lbf/in <sup>2</sup> (bar)	lbf/in <sup>2</sup> (bar)
All engines	185/60 R15 <sup>*</sup>	35 (2.4)	31 (2.1)	38 (2.6)	46 (3.2)
All engines	195/60 R15	32 (2.2)	31 (2.1)	36 (2.5)	46 (3.2)
All engines	195/55 R16	32 (2.2)	32 (2.2)	36 (2.5)	41 (2.8)
All engines	205/45 R17	35 (2.4)	31 (2.1)	38 (2.6)	41 (2.8)



# Capacities and Specifications

## VEHICLE IDENTIFICATION PLATE

**Note:** Your vehicle identification plate design may vary to that shown.

**Note:** The information shown on the vehicle identification plate is dependant upon market requirements.

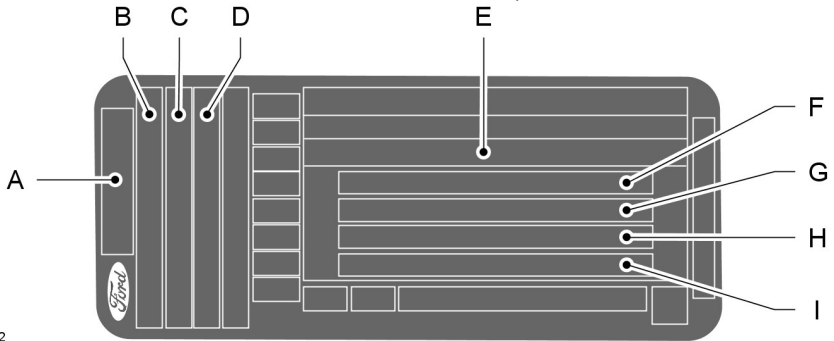

E135662

- A Model
- B Variant
- C Engine designation
- D Emission level
- E Vehicle identification number
- F Gross vehicle weight
- G Gross train weight
- H Maximum front axle weight
- I Maximum rear axle weight

Your vehicle identification number and maximum weights are shown on a plate located on the lock side of the right-hand door aperture at the bottom.

# Capacities and Specifications

## VEHICLE IDENTIFICATION NUMBER

Your vehicle identification number is stamped into the floor panel on the right-hand side, beside the front seat. It is also shown on the left-hand side of the instrument panel.

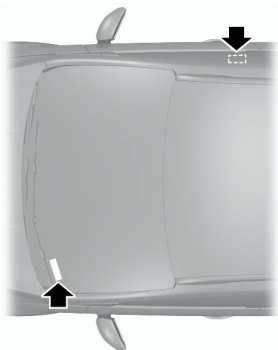

E87496

## TECHNICAL SPECIFICATIONS

### Vehicle dimensions

<b>Dimension description</b>	<b>Dimension in inches (mm)</b>
Maximum length	160.5 (4077)
Overall width including exterior mirrors	81.4 (2067)
Overall height - EC kerb weight	63.1 - 63.5 (1604 - 1613)
Wheelbase	98.0 (2489)
Front track	58.5 - 58.7 (1487 - 1492)
Rear track	58.1 - 58.3 (1477 - 1482)

# Capacities and Specifications

## Towing equipment dimensions

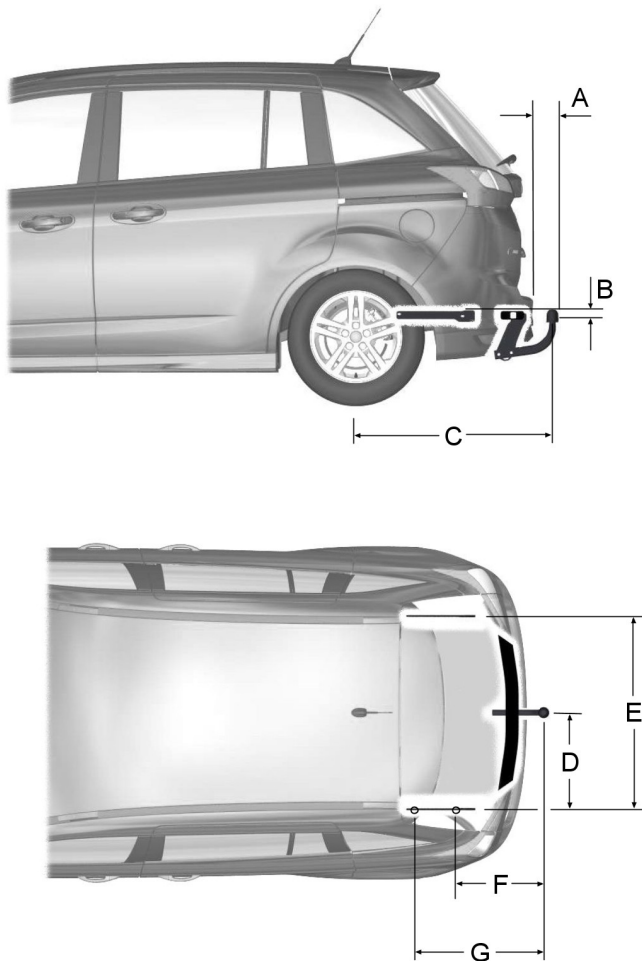

E130084

## Capacities and Specifications

---

<b>Item</b>	<b>Dimension description</b>	<b>Dimension in inches (mm)</b>
A	Bumper – end of tow ball	3.1 (78)
B	Attachment point – centre of tow ball	0.7 (18)
C	Wheel centre – centre of tow ball	33.3 (845)
D	Centre of tow ball – side member	20.3 (516)
E	Distance between side members	40.6 (1032)
F	Centre of tow ball – centre 1. attachment point	16.5 (419)
G	Centre of tow ball – centre 2. attachment point	26.3 (668)

# Audio System

## GENERAL INFORMATION

### Radio Frequencies and Reception Factors

## WARNING



Radio sound levels can go above 85dCB. Listening to sounds about 85 decibels can harm the human auditory system.

Radio Reception Factors	
Distance/Strength	The further you travel from an FM station, the weaker the signal and the weaker the reception.
Terrain	Hills, mountains, tall buildings, bridges, tunnels, motorway overpasses, parking garages, dense tree foliage and thunderstorms can interfere with your reception.
Station overload	When you pass near a radio transmission tower, a stronger signal can override a weaker signal and can cause interference in the audio system.

### CD and CD Player Information

**Note:** CD units are designed to play commercially-pressed 4.75 inch (12 centimetre) audio compact discs only. Due to technical incompatibility, certain recordable and re-recordable compact discs may not function correctly when used in Ford CD players.

**Note:** CDs with homemade paper (adhesive) labels should not be inserted into the CD player as the label may peel and cause the CD to become jammed. It is recommended that homemade CDs be identified with permanent felt tip marker rather than adhesive labels. Ballpoint pens may damage CDs. Contact an authorised dealer for further information.

**Note:** Do not use any irregularly shaped discs or discs with a scratch protection film attached.

Always handle discs by their edges only. Clean the disc with an approved CD cleaner only, wiping from the centre of the disc toward the edge. Do not clean in a circular motion.

Do not expose discs to direct sunlight or heat sources for extended periods of time.

### MP3 and WMA Track and Folder Structure

Audio systems capable of recognising and playing MP3 and WMA individual tracks and folder structures work as follows:

- There are two different modes for MP3 and WMA disc playback: MP3 and WMA track mode (system default) and MP3 and WMA folder mode.
- MP3 and WMA track mode ignores any folder structure on the MP3 and WMA disc. The player numbers each MP3 and WMA track on the disc (noted by the .mp3 file extension) from T001 to a maximum of T255. The maximum number of playable MP3 and WMA files may be less depending on the structure of the CD and exact model of radio present.

# Audio System

---

- MP3 and WMA folder mode represents a folder structure consisting of one level of folders. The CD player numbers all MP3 and WMA tracks on the disc (noted by the .mp3 or . WMA file extension) and all folders containing MP3 and WMA files, from F001 (folder) T001 (track) to F253 T255.
- Creating discs with only one level of folders helps with navigation through the disc files.

If you are burning your own MP3 and WMA discs, it is important to understand how the system reads the structures you create. While various files may be present, (files with extensions other than mp3 and WMA), only files with the .mp3 and WMA extension are played; other files are ignored by the system. This enables you to use the same MP3 and WMA disc for a variety of tasks on your work computer, home computer and your in-vehicle system.

In track mode, the system displays and plays the structure as if it were only one level deep (all .mp3 and WMA files are played, regardless of being in a specific folder). In folder mode, the system only plays the .mp3 or WMA files in the current folder.

## **AUDIOUNIT - VEHICLES WITH: AM/FM/CD**

### **WARNING**



Driving while distracted can result in loss of vehicle control, accident and injury. We strongly recommend that you use extreme caution when using any device or feature that may take your focus off the road. Your primary responsibility is the safe operation of your vehicle. We recommend against the use of any handheld device while driving and encourage the use of voice-operated systems when possible. Make sure you are aware of all applicable local laws that may affect the use of electronic devices while driving.

---

# Audio System

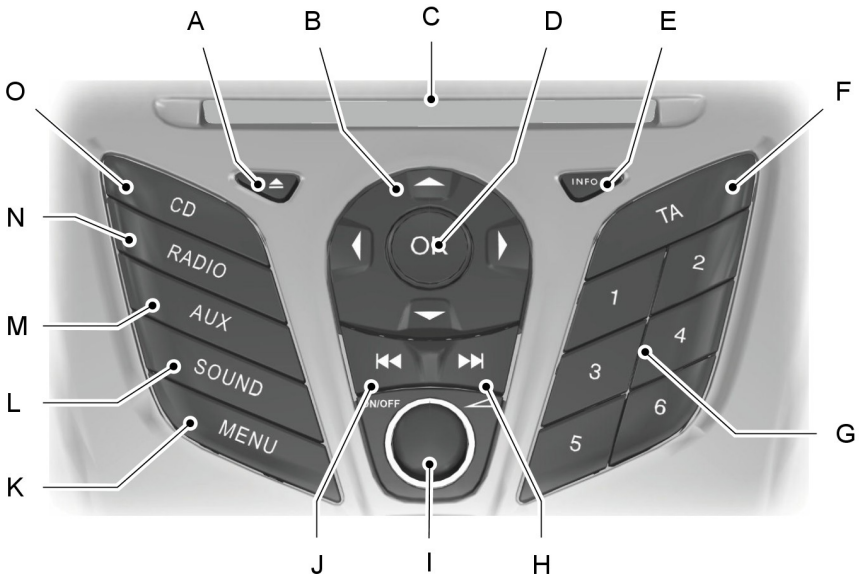

E130324

- A **Eject:** Press the button to eject a CD.
- B **Cursor arrows:** Press a button to scroll through on-screen choices.
- C **CD slot:** Where you insert a CD.
- D **OK:** Press the button to confirm on-screen selections.
- E **INFO:** Press the button to access radio, CD, USB and iPod information.
- F **TA:** Press the button to turn traffic announcements on or off and cancels announcements during an active announcement.
- G **Numeric keypad:** Press the button to recall a previously stored station. To store a favourite station press and hold until the sound returns.
- H **Seek up:** Press the button to go to the next station up the radio frequency band or the next track on a CD.
- I **On, Off and Volume:** Press the button to switch the audio system on or off. Turn the dial to adjust the volume.
- J **Seek down:** Press the button to go to the next station down the radio frequency band or the previous track on a CD.

# Audio System

---

- K **MENU:** Press the button to access different audio system features.
- L **SOUND:** Press the button to adjust the sound settings for bass, treble, middle, balance and fade.
- M **AUX:** Press the button to access the AUX and SYNC features, it will also cancel the menu or list browsing.
- N **RADIO:** Press the button to select different radio bands, it will also cancel the menu or list browsing.
- O **CD:** Press the button to change source to CD, it will also cancel the menu or list browsing.

## Sound Button

This will allow you to adjust the sound settings (for example bass, middle and treble).

1. Press the **SOUND** button.
2. Use the up and down arrow buttons to select the required setting.
3. Use the left and right arrow buttons to make the necessary adjustment. The display indicates the level selected.
4. Press the **OK** button to confirm the new settings.

## Waveband Button

Press the **RADIO** button to select from the wavebands available.

You can use the selector to return to radio reception when you have been listening to another source.

Alternatively, press the left arrow button to display the available wavebands. Scroll to the required waveband and press **OK**.

## Station Tuning Control

### Seek Tuning

Select a waveband and briefly press one of the seek buttons. The unit will stop at the first station it finds in the direction you have chosen.

## Manual Tuning

1. Press the **MENU** button.
2. Select **RADIO** mode and then **MANUAL TUNE**.
3. Use the left and right arrow buttons to tune down or up the waveband in small increments or press and hold to increment quickly, until you find a station you want to listen to.
4. Press **OK** to continue listening to a station.

## Scan Tuning

Scan allows you to listen to a few seconds of each station detected.

1. Press the **MENU** button.
2. Select **RADIO** mode and then **SCAN**.
3. Use the seek buttons to scan up or down the selected waveband.
4. Press **OK** to continue listening to a station.

## Station Preset Buttons

This feature allows you to store your favourite stations, they can be recalled by selecting the appropriate waveband and pressing one of the preset buttons.

1. Select a waveband.
2. Tune to the station required.



# Audio System

---

3. Press and hold one of the preset buttons. A progress bar and message will appear. When the progress bar completes the station has been stored. The audio unit will also mute momentarily as confirmation.

You can repeat this on each waveband and for each preset button.

**Note:** *When you drive to another part of the country, stations that broadcast on alternative frequencies and are stored on preset buttons, may be updated with the correct frequency and station name for that area.*

## Autostore Control

**Note:** *This will store up to a maximum of the six strongest signals available, either from the AM or the FM waveband and overwrite the previously stored stations. You can also store stations manually in the same way as other wavebands.*

- Press the **MENU** button, select **RADIO** mode, press **AUTOSTORE**.
- When the search is complete, sound is restored and the strongest signals are stored on the autostore presets.

## Traffic Information Control

Many stations that broadcast on the FM waveband have a TP code to signify that they carry traffic program information.

## Turning Traffic Announcements On and Off

Before you can receive traffic announcements, you must press either the **TA** or **TRAFFIC** button. A TA display will appear to show the feature is switched on.

If you are already tuned to a station that broadcasts traffic information, **TP** will also be displayed. Otherwise the unit will search for a traffic program.

When traffic information is broadcast, it will automatically interrupt normal radio or CD playback and **Traffic announcement** will appear in the display.

If a non-traffic station is selected or recalled using a preset button, the audio unit will remain on that station unless **TA** or **TRAFFIC** is turned off, then on again.

**Note:** *If traffic announcement is on and you select a preset or manual tune to a non traffic announcement station no traffic announcement will be heard.*

**Note:** *When you are listening to a non traffic announcement station and turn traffic announcement off and on again a TP seek will occur.*

## Traffic Announcement Volume

Traffic announcements interrupt normal broadcasts at a preset minimum level that is usually louder than normal listening volumes.

To adjust the preset volume:

- Use the volume control to make the necessary adjustment during an incoming traffic announcement broadcast. The display will show the level selected.

## Ending Traffic Announcements

The audio unit will return to normal operation at the end of each traffic announcement. To end the announcement prematurely, press **TA** or **TRAFFIC** during the announcement.

**Note:** *If you press TA or TRAFFIC at any other time it will switch all announcements off.*

## Automatic Volume Control

When available, automatic volume control adjusts the volume level to compensate for engine noise and road speed noise.

# Audio System

---

1. Press the **MENU** button and select **AUDIO** or **AUDIO SETTINGS**.
2. Select **AVC LEVEL** or **ADAPTIVE VOL**.
3. Use the left or right arrow button to adjust the setting.
4. Press the **OK** button to confirm your selection.
5. Press the **MENU** button to return.

## News Broadcasts

Your audio unit may interrupt normal reception to broadcast news bulletins from stations on the FM waveband, radio data system or other enhanced network linked stations.

The display will indicate there is an incoming announcement, during news broadcasts. When the audio unit interrupts for a news broadcast the preset volume level will be the same as traffic announcements.

1. Press the **MENU** button.
2. Select **AUDIO** or **AUDIO SETTINGS**.
3. Scroll to **NEWS** and turn on or off with the **OK** button.
4. Press the **MENU** button to return.

## Alternative Frequencies

The majority of programs that broadcast on the FM waveband have a program identification code, it can be recognised by audio units.

When your vehicle moves from one transmission area to another with the alternative frequencies tuning switched on, this function will search for the strongest station signal.

Under certain conditions, alternative frequencies tuning may temporarily disrupt normal reception.

When selected, the unit continually evaluates signal strength and if a better signal becomes available, the unit will switch to that alternative. It mutes while it checks a list of alternative frequencies and if necessary, it will search once across the selected waveband for a genuine alternative frequency.

It will restore radio reception when it finds one or if one is not found, the unit will return to the original stored frequency.

When selected, **AF** will be shown in the display.

1. Press the **MENU** button.
2. Select **AUDIO** or **AUDIO SETTINGS**.
3. Scroll to **ALTERNAT FREQ** or **ALTERNATIVE FREQ** and turn on or off with the **OK** button.
4. Press the **MENU** button to return.

## Regional Mode

Regional mode controls the behavior of alternative frequencies switching between regionally related networks of a parent broadcaster. A broadcaster may run a fairly large network across a large part of the country. At various times of the day this large network may be broken down into a number of smaller regional networks, typically centred on major towns or cities. When the network is not split into regional variants, the whole network carries the same programming.

Regional mode ON: This prevents random alternative frequency switches when neighbouring regional networks are not carrying the same programming.

Regional mode OFF: This allows a larger coverage area if neighbouring regional networks are carrying the same programming, but can cause random alternative frequency switches if they are not.

1. Press the **MENU** button.

# Audio System

2. Select **AUDIO** or **AUDIO SETTINGS**.
3. Scroll to **RDS REGIONAL** and turn on or off with the **OK** button.
4. Press the **MENU** button to return.

## AUDIO UNIT - VEHICLES WITH: AM/FM/CD/BLUETOOTH

### WARNING

 Driving while distracted can result in loss of vehicle control, accident and injury. We strongly recommend that you use extreme caution when using any device or feature that may take your focus off the road. Your primary responsibility is the safe operation of your vehicle. We recommend against the use of any handheld device while driving and encourage the use of voice-operated systems when possible. Make sure you are aware of all applicable local laws that may affect the use of electronic devices while driving.

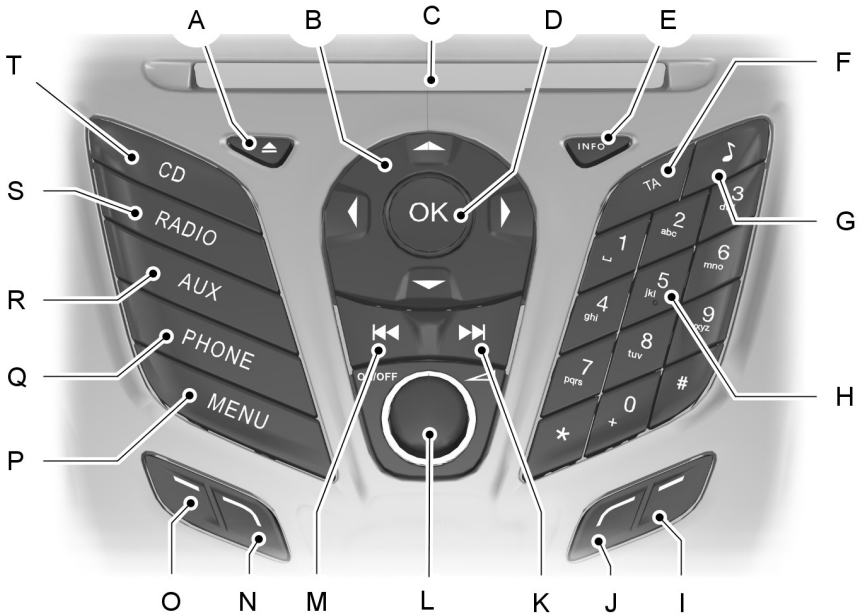

E130142

# Audio System

---

- A **Eject:** Press the button to eject a CD.
- B **Cursor arrows:** Press a button to scroll through on-screen choices.
- C **CD slot:** Where you insert a CD.
- D **OK:** Press the button to confirm on-screen selections.
- E **INFO:** Press the button to access radio, CD, USB and iPod information.
- F **TA:** Press the button to turn traffic announcements on or off and cancels announcements during an active announcement.
- G **Sound:** Press the button to adjust the sound settings for bass, treble, middle, balance and fade.
- H **Numeric keypad:** Press the button to recall a previously stored station. To store a favourite station press and hold until the sound returns.
- I **Function button 4:** Press the button to select different functions of the audio system depending on which mode (i.e. radio or CD) you are in.
- J **Function button 3:** Press the button to select different functions of the audio system depending on which mode (i.e. radio or CD) you are in.
- K **Seek up:** Press the button to go to the next station up the radio frequency band or the next track on a CD.
- L **On, Off and Volume:** Press the button to switch the audio system on or off. Turn the dial to adjust the volume.
- M **Seek down:** Press the button to go to the next station down the radio frequency band or the previous track on a CD.
- N **Function button 2:** Press the button to select different functions of the audio system depending on which mode (i.e. radio or CD) you are in.
- O **Function button 1:** Press the button to select different functions of the audio system depending on which mode (i.e. radio or CD) you are in.
- P **MENU:** Press the button to access different audio system features.
- Q **PHONE:** Press the button to access the phone feature of the SYNC system by pressing PHONE then MENU. See separate manual.
- R **AUX:** Press the button to access the AUX and SYNC features, it will also cancel the menu or list browsing.
- S **RADIO:** Press the button to select different radio bands, it will also cancel the menu or list browsing.
- T **CD:** Press the button to change source to CD, it will also cancel the menu or list browsing.

# Audio System

---

## Sound Button

This will allow you to adjust the sound settings (for example bass, middle and treble).

1. Press the sound button.
2. Use the up and down arrow buttons to select the required setting.
3. Use the left and right arrow buttons to make the necessary adjustment. The display indicates the level selected.
4. Press the **OK** button to confirm the new settings.

## Waveband Button

Press the **RADIO** button to select from the wavebands available.

You can use the selector to return to radio reception when you have been listening to another source.

Alternatively, press the left arrow button to display the available wavebands. Scroll to the required waveband and press **OK**.

## Station Tuning Control

### DAB Service Linking

**Note:** *The DAB service linking is as per default off.*

**Note:** *Service linking allows cross-referencing to other corresponding frequencies of the same station, for example FM and other DAB ensembles.*

**Note:** *The system will automatically change to another corresponding station if the current one becomes unavailable, for example when leaving the coverage area.*

Switching DAB service linking on and off. See **General Information** (page 58).

## Seek Tuning

Select a waveband and briefly press one of the seek buttons. The unit will stop at the first station it finds in the direction you have chosen.

## Manual Tuning

1. Press **function button 2**.
2. Use the left and right arrow buttons to tune down or up the waveband in small increments or press and hold to increment quickly, until you find a station you want to listen to.
3. Press **OK** to continue listening to a station.

## Scan Tuning

Scan allows you to listen to a few seconds of each station detected.

1. Press **function button 3**.
2. Use the seek buttons to scan up or down the selected waveband.
3. Press **function button 3** again or **OK** to continue listening to a station.

## Station Preset Buttons

This feature allows you to store your favourite stations, they can be recalled by selecting the appropriate waveband and pressing one of the preset buttons.

1. Select a waveband.
2. Tune to the station required.
3. Press and hold one of the preset buttons. A progress bar and message will appear. When the progress bar completes the station has been stored. The audio unit will also mute momentarily as confirmation.

You can repeat this on each waveband and for each preset button.

# Audio System

---

**Note:** When you drive to another part of the country, stations that broadcast on alternative frequencies, and are stored on preset buttons, may be updated with the correct frequency and station name for that area.

## Autostore Control

**Note:** This will store up to a maximum of the 10 strongest signals available, either from the AM or the FM waveband, and overwrite the previously stored stations. You can also store stations manually in the same way as other wavebands.

- Press the **MENU** button, select audio mode then press and hold the **RADIO** button.
- When the search is complete, sound is restored and the strongest signals are stored on the autostore presets.

## Traffic Information Control

Many stations that broadcast on the FM waveband have a TP code to signify that they carry traffic program information.

### Turning Traffic Announcements On and Off

Before you can receive traffic announcements, you must press either the **TA** or **TRAFFIC** button. A TA display will appear to show the feature is switched on.

If you are already tuned to a station that broadcasts traffic information, **TP** will also be displayed. Otherwise the unit will search for a traffic program.

When traffic information is broadcast, it will automatically interrupt normal radio or CD playback and **Traffic announcement** will appear in the display.

If a non-traffic station is selected or recalled using a preset button, the audio unit will remain on that station unless **TA** or **TRAFFIC** is turned off, then on again.

**Note:** If traffic announcement is on and you select a preset or manual tune to a non traffic announcement station no traffic announcement will be heard.

**Note:** When you are listening to a non traffic announcement station and turn traffic announcement off and on again a TP seek will occur.

## Traffic Announcement Volume

Traffic announcements interrupt normal broadcasts at a preset minimum level that is usually louder than normal listening volumes.

To adjust the preset volume:

- Use the volume control to make the necessary adjustment during an incoming traffic announcement broadcast. The display will show the level selected.

## Ending Traffic Announcements

The audio unit will return to normal operation at the end of each traffic announcement. To end the announcement prematurely, press **TA** or **TRAFFIC** during the announcement.

**Note:** If you press **TA** or **TRAFFIC** at any other time it will switch all announcements off.

## Automatic Volume Control

When available, automatic volume control adjusts the volume level to compensate for engine noise and road speed noise.

1. Press the **MENU** button and select **AUDIO** or **AUDIO SETTINGS**.
2. Select **AVC LEVEL** or **ADAPTIVE VOL**.
3. Use the left or right arrow button to adjust the setting.
4. Press the **OK** button to confirm your selection.

# Audio System

---

5. Press the **MENU** button to return.

## News Broadcasts

Your audio unit may interrupt normal reception to broadcast news bulletins from stations on the FM waveband, radio data system or other enhanced network linked stations.

The display will indicate there is an incoming announcement, during news broadcasts. When the audio unit interrupts for a news broadcast the preset volume level will be the same as traffic announcements.

1. Press the **MENU** button.
2. Select **AUDIO** or **AUDIO SETTINGS**.
3. Scroll to **NEWS** and turn on or off with the **OK** button.
4. Press the **MENU** button to return.

## Alternative Frequencies

The majority of programs that broadcast on the FM waveband have a program identification code, it can be recognised by audio units.

When your vehicle moves from one transmission area to another with the alternative frequencies tuning switched on, this function will search for the strongest station signal.

Under certain conditions, alternative frequencies tuning may temporarily disrupt normal reception.

When selected, the unit continually evaluates signal strength and, if a better signal becomes available, the unit will switch to that alternative. It mutes while it checks a list of alternative frequencies and if necessary, it will search once across the selected waveband for a genuine alternative frequency.

It will restore radio reception when it finds one or if one is not found, the unit will return to the original stored frequency.

When selected, AF will be shown in the display.

1. Press the **MENU** button.
2. Select **AUDIO** or **AUDIO SETTINGS**.
3. Scroll to **ALTERNAT FREQ.** or **ALTERNATIVE FREQ.** and turn on or off with the **OK** button.
4. Press the **MENU** button to return.

## Regional Mode

Regional mode controls the behaviour of alternative frequencies switching between regionally related networks of a parent broadcaster. A broadcaster may run a fairly large network across a large part of the country. At various times of the day this large network may be broken down into a number of smaller regional networks, typically centred on major towns or cities. When the network is not split into regional variants, the whole network carries the same programming.

Regional mode ON: This prevents random alternative frequency switches when neighbouring regional networks are not carrying the same programming.

Regional mode OFF: This allows a larger coverage area if neighbouring regional networks are carrying the same programming, but can cause random alternative frequency switches if they are not.

1. Press the **MENU** button.
2. Select **AUDIO** or **AUDIO SETTINGS**.
3. Scroll to **RDS REGIONAL** and turn on or off with the **OK** button.
4. Press the **MENU** button to return.

# Audio System

## AUDIO UNIT - VEHICLES WITH: SONY AM/FM/CD

### WARNING



Driving while distracted can result in loss of vehicle control, accident and injury. We strongly recommend that you use extreme caution when using any device or feature that may take your focus off the road. Your primary responsibility is the safe operation of your vehicle. We recommend against the use of any handheld device while driving and encourage the use of voice-operated systems when possible. Make sure you are aware of all applicable local laws that may affect the use of electronic devices while driving.

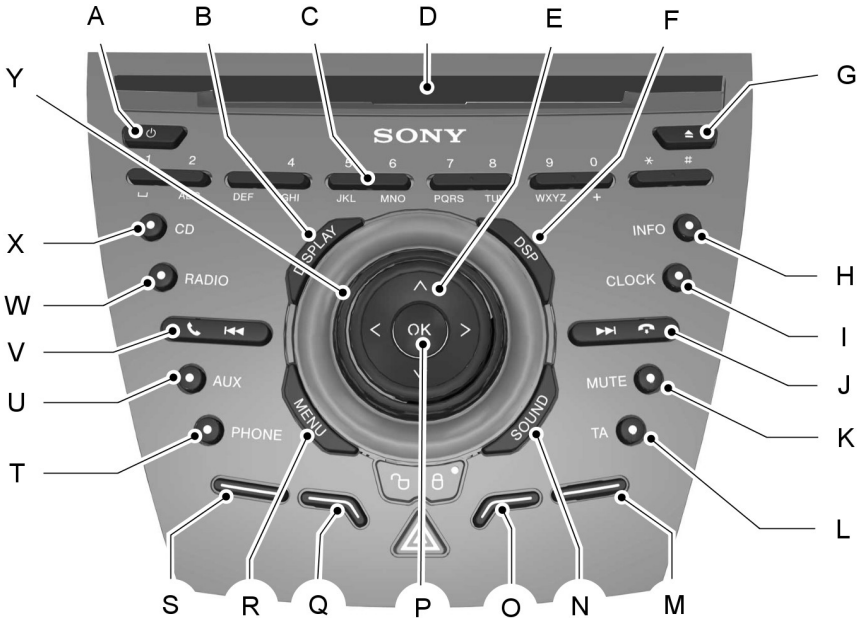

E129074

- A **On, Off:** Press the button to switch the audio system on or off.
- B **DISPLAY:** Press the button to turn on the display into idle mode.



# Audio System

---

- C **Numeric keypad:** Press the button to recall a previously stored station. To store a favourite station press and hold until the sound returns.
- D **CD slot:** Where you insert a CD.
- E **Cursor arrows:** Press the button to scroll through on-screen choices.
- F **Digital signal processing:** Press the button to access the digital signal processing functions.
- G **Eject:** Press the button to eject a CD.
- H **INFO:** Press the button to access radio, CD, USB and iPod information.
- I **CLOCK:** Press the button to access the clock functions.
- J **Seek up:** Press the button to go to the next station up the radio frequency band or the next track on a CD when in CD mode. In phone mode, use the button to end a phone call. An incoming call can be rejected.
- K **MUTE:** Press the button to turn the sound off, press again to turn the sound on.
- L **TA:** Press the button to turn traffic announcements on or off and cancels announcements during an active announcement.
- M **Function button 4:** Press the button to select different functions of the audio system depending on which mode (i.e. radio or CD) you are in.
- N **SOUND:** Press the button to adjust the sound settings for bass, treble, middle, balance and fade.
- O **Function button 3:** Press the button to select different functions of the audio system depending on which mode (i.e. radio or CD) you are in.
- P **OK:** Press the button to confirm on-screen selections.
- Q **Function button 2:** Press the button to select different functions of the audio system depending on which mode (i.e. radio or CD) you are in.
- R **MENU:** Press the button to access different audio system features.
- S **Function button 1:** Press the button to select different functions of the audio system depending on which mode (i.e. radio or CD) you are in.
- T **PHONE:** Press the button to access the phone feature of the SYNC system by pressing **PHONE** then **MENU**. See separate manual.
- U **AUX:** Press the button to access the AUX and SYNC features, it will also cancel the menu or list browsing.
- V **Seek down:** Press the button to go to the next station down the radio frequency band or the previous track on a CD, When in CD mode. In phone mode use the button to begin a phone call. An incoming phone call can be accepted.
- W **RADIO:** Press the button to select different radio bands, it will also cancel the menu or list browsing.

# Audio System

---

- X **CD:** Press the button to change source to CD, it will also cancel the menu or list browsing.
- Y **Volume:** Turn the dial to adjust the volume.

## Sound Button

This will allow you to adjust the sound settings (for example bass, middle and treble).

1. Press the **SOUND** button.
2. Use the up and down arrow buttons to select the required setting.
3. Use the left and right arrow buttons to make the necessary adjustment. The display indicates the level selected.
4. Press the **OK** button to confirm the new settings.

## Waveband Button

Press the **RADIO** button to select from the wavebands available.

You can use the selector to return to radio reception when you have been listening to another source.

Alternatively, press the left arrow button to display the available wavebands. Scroll to the required waveband and press **OK**.

## Station Tuning Control

### DAB Service Linking

**Note:** *The DAB service linking is as per default off.*

**Note:** *Service linking allows cross-referencing to other corresponding frequencies of the same station, for example FM and other DAB ensembles.*

**Note:** *The system will automatically change to another corresponding station if the current one becomes unavailable, for example when leaving the coverage area.*

Switching DAB service linking on and off. See **General Information** (page 58).

## Seek Tuning

Select a waveband and briefly press one of the seek buttons. The unit will stop at the first station it finds in the direction you have chosen.

## Manual Tuning

1. Press function button 2.
2. Use the left and right arrow buttons to tune down or up the waveband in small increments or press and hold to increment quickly, until you find a station you want to listen to.
3. Press **OK** to continue listening to a station.

## Scan Tuning

Scan allows you to listen to a few seconds of each station detected.

1. Press function button 3.
2. Use the seek buttons to scan up or down the selected waveband.
3. Press function button 3 again or **OK** to continue listening to a station.

## Station Preset Buttons

This feature allows you to store your favourite stations, they can be recalled by selecting the appropriate waveband and pressing one of the preset buttons.

1. Select a waveband.
2. Tune to the station required.

# Audio System

---

3. Press and hold one of the preset buttons. A progress bar and message will appear. When the progress bar completes the station has been stored. The audio unit will also mute momentarily as confirmation.

You can repeat this on each waveband and for each preset button.

**Note:** *When you drive to another part of the country, stations that broadcast on alternative frequencies, and are stored on preset buttons, may be updated with the correct frequency and station name for that area.*

## Autostore Control

**Note:** *This will store up to a maximum of the 10 strongest signals available, either from the AM or the FM waveband, and overwrite the previously stored stations. You can also store stations manually in the same way as other wavebands.*

**Note:** *You must select either **FM AST** or **AM AST** to use this function.*

- Press the **MENU** button, select audio mode then press and hold the **RADIO** button.
- When the search is complete, sound is restored and the strongest signals are stored on the autostore presets.

## Traffic Information Control

Many stations that broadcast on the FM waveband have a TP code to signify that they carry traffic program information.

## Turning Traffic Announcements On and Off

Before you can receive traffic announcements, you must press either the **TA** or **TRAFFIC** button. A TA display will appear to show the feature is switched on.

If you are already tuned to a station that broadcasts traffic information, **TP** will also be displayed. Otherwise the unit will search for a traffic program.

When traffic information is broadcast, it will automatically interrupt normal radio or CD playback and Traffic announcement will appear in the display.

If a non-traffic station is selected or recalled using a preset button, the audio unit will remain on that station unless **TA** or **TRAFFIC** is turned off, then on again.

**Note:** *If traffic announcement is on and you select a preset or manual tune to a non traffic announcement station no traffic announcement will be heard.*

**Note:** *When you are listening to a non traffic announcement station and turn traffic announcement off and on again a TP seek will occur.*

## Traffic Announcement Volume

Traffic announcements interrupt normal broadcasts at a preset minimum level that is usually louder than normal listening volumes.

To adjust the preset volume:

- Use the volume control to make the necessary adjustment during an incoming traffic announcement broadcast. The display will show the level selected.

## Ending Traffic Announcements

The audio unit will return to normal operation at the end of each traffic announcement. To end the announcement prematurely, press **TA** or **TRAFFIC** during the announcement.

**Note:** *If you press **TA** or **TRAFFIC** at any other time it will switch all announcements off.*

# Audio System

---

## Automatic Volume Control

When available, automatic volume control adjusts the volume level to compensate for engine noise and road speed noise.

1. Press the **MENU** button and select **AUDIO**.
2. Select **AVC LEVEL** or **ADAPTIVE VOL**.
3. Use the left or right arrow button to adjust the setting.
4. Press the **OK** button to confirm your selection.
5. Press the **MENU** button to return.

## Digital Signal Processing

### Digital Signal Processing Occupancy

This feature takes into account the differences in distance from the various speakers in your vehicle to each seat. You must select the correct sitting position for the audio to be correctly set.

### Digital Signal Processing Equaliser

Select the music category that most suits your listening preference. The audio output will change to enhance the particular style of music chosen.

### Changing the Digital Signal Processing Settings

1. Press the **MENU** button.
2. Select **AUDIO** or **AUDIO SETTINGS**.
3. Scroll to the required digital signal processing function.
4. Use the up and down arrow buttons to select the required setting.
5. Press the **OK** button to confirm your selection.
6. Press the **MENU** button to return.

## News Broadcasts

Your audio unit may interrupt normal reception to broadcast news bulletins from stations on the FM waveband, radio data system or other enhanced network linked stations.

The display will indicate there is an incoming announcement, during news broadcasts. When the audio unit interrupts for a news broadcast the preset volume level will be the same as traffic announcements.

1. Press the **MENU** button.
2. Select **AUDIO** or **AUDIO SETTINGS**.
3. Scroll to **NEWS** and turn on or off with the **OK** button.
4. Press the **MENU** button to return.

## Alternative Frequencies

The majority of programs that broadcast on the FM waveband have a program identification code, it can be recognised by audio units.

When your vehicle moves from one transmission area to another with the alternative frequencies tuning switched on, this function will search for the strongest station signal.

Under certain conditions, however, alternative frequencies tuning may temporarily disrupt normal reception.

When selected, the unit continually evaluates signal strength and, if a better signal becomes available, the unit will switch to that alternative. It mutes while it checks a list of alternative frequencies and if necessary, it will search once across the selected waveband for a genuine alternative frequency.

It will restore radio reception when it finds one or if one is not found, the unit will return to the original stored frequency.

# Audio System

---

When selected, AF will be shown in the display.

1. Press the **MENU** button.
2. Select **AUDIO** or **AUDIO SETTINGS**.
3. Scroll to **ALTERNAT FREQ.** or **ALTERNATIVE FREQ.** and turn on or off with the OK button.
4. Press the **MENU** button to return.

## Regional Mode

Regional mode controls the behaviour of alternative frequencies switching between regionally related networks of a parent broadcaster. A broadcaster may run a fairly large network across a large part of the country. At various times of the day this large network may be broken down into a number of smaller regional networks, typically centred on major towns or cities. When the network is not split into regional variants, the whole network carries the same programming.

Regional mode ON: This prevents random alternative frequency switches when neighbouring regional networks are not carrying the same programming.

Regional mode OFF: This allows a larger coverage area if neighbouring regional networks are carrying the same programming, but can cause 'random' alternative frequency switches if they are not.

1. Press the **MENU** button.
2. Select **AUDIO** or **AUDIO SETTINGS**.
3. Scroll to **RDS REGIONAL** and turn on or off with the **OK** button.
4. Press the **MENU** button to return.

## AUDIO SYSTEM SECURITY

Each unit incorporates a unique code that is linked to the vehicle identification number. The system will automatically check that the audio unit and vehicle match before allowing operation.

If a security code message appears, see an authorised dealer.

## COMPACT DISC PLAYER - VEHICLES WITH: AM/FM/CD

### Compact Disc Playback

**Note:** *During playback, the display indicates the disc, track and time that has elapsed since the start of the track.*

During radio reception, press the **CD** button once to start CD playback.

After a disc is loaded, playback will start immediately.

### Track Selection

- Press the seek down button once to replay the current track. If pressed within two seconds of the start of a track, the previous track will be selected.
- Press the up or down arrow buttons to select the required track, then press the **OK** button.

### Fast Forward and Reverse

Press and hold the seek down or up buttons to search backward or forward within the tracks on the disc.

### Shuffle and Random

Random track playback, also known as shuffle, plays all tracks on the CD in random order.

# Audio System

---

1. Press the **MENU** button and select **CD MODE**.
2. Select **SHUFFLE**. This enables the function to be switched on or off.

When an MP3 CD is playing, options include **SHUFFLE** for the whole CD, or to play all the tracks in the folder in a random order.

## Repeat Compact Disc Tracks

1. Press the **MENU** button and select **CD MODE**.
2. Select **REPEAT**. This enables the function to be switched on or off. The track will replay once ended.

When an MP3 or WMA CD is playing, options include **REPEAT** for the track, or to repeat all the tracks in the folder.

## Compact Disc Track Scanning

The **SCAN** function allows you to preview each track for approximately five seconds.

Various scan modes are possible, according to the type of CD currently playing.

1. Press the **MENU** button and select **CD MODE**.
2. Select **SCAN**. This enables the function to be switched on or off.

**Note:** When an MP3 or WMA CD is playing, options include **SCAN** for the CD or just the tracks in the folder.

3. Press the **OK** button to stop the scan mode.

## MP3 and WMA File Playback

MP3 (MPEG 1 Audio Layer-3) or WMA (Windows media audio) is a standard technology and format for compressing audio data. This allows a more efficient use of the media.

You can play MP3 files recorded on CD-ROM, CD-R and CD-RW formats. The disc must be in the ISO 9660 level 1 or level 2 format, or Joliet or Romeo in the expansion format. You can also use a disc recorded in multi session.

## ISO 9660 Format

This is the most common international standard for the logical format of files and folders on a CD-ROM.

There are several specification levels. In Level 1, file names must be in the 8.3 format (no more than eight characters in the name, no more than three characters in the extension .MP3 and .WMA) and in capital letters.

Folder names can be no longer than eight characters. There can be no more than eight folder levels (trees). Level 2 specifications allow file names up to 31 characters long.

Each folder can have up to eight trees.

For Joliet or Romeo in the expansion format, consider these restrictions when configuring your CD writing software.

## Multi Session

This is a recording method that enables adding of data using the track-at-once method.

Conventional CDs begin at a CD control area called the lead-in and end at an area called lead-out. A multi session CD is a CD having multiple sessions, with each segment from lead-in to lead-out regarded as a single session.

CD-Extra: The format that records audio (audio CD data) as tracks on session 1, and records data as tracks on session 2.

Mixed CD: In this format, data is recorded as track 1 and audio (audio CD data) is recorded as track 2.

# Audio System

## File Formats

With formats other than ISO 9660 level 1 and level 2, folder names or file names may not be displayed correctly.

When naming, be sure to add the file extension .MP3 or . WMA to the file name.

If you put the extension .MP3 or . WMA to a file other than MP3 or WMA, the unit cannot recognise the file correctly and will generate random noise that could damage your speakers.

The following discs take a longer time to start playback.

- A disc recorded with complicated tree structure.
- A disc recorded in multi session.
- A non-finalised disc to which data can be added.

## Playing a Multi Session Disc

When the first track of the first session is audio CD data only, the audio CD data of the first session is played back. Non-audio CD data, MP3 or WMA file information (track number, time, etc.) is displayed with no sound.

When the first track of the first session is not audio CD data:

- If an MP3 or WMA file is on the disc, only MP3, WMA or other data is skipped. Audio CD data is not recognised.
- If no MP3 or WMA file is in the disc, nothing is played back. Audio CD data is not recognised.

## MP3 and WMA Files Playback Order

The playback order of the folders and files are as shown.

**Note:** A folder that does not include an MP3 or WMA file is skipped.

To specify a desired playback order before the folder or file name. Input the order by number (e.g., 01, 02) then record contents onto a disc. The order differs depending on the writing software.

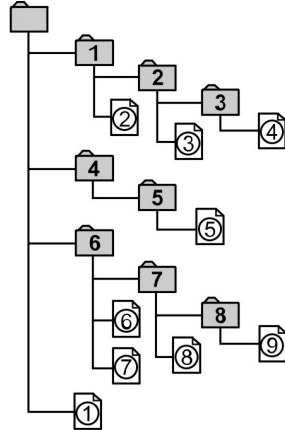

E104206

## ID3 Tag Version 2

The following occurs when an MP3 or WMA file containing a tag is played:

- When skipping a portion of a tag (at the beginning of the track) there is no sound output. Skip time changes depending the tag capacity. Example: At 64 kbytes, it is about 2 seconds (with RealJukebox).
- The displayed elapsed playing time when skipping a portion of the tag is inaccurate. For MP3 files of a bit rate other than 128 kbps, time is not displayed accurately during playback.
- When an MP3 file is created with MP3 conversion software (e.g. RealJukebox - a registered trademark of RealNetworks Inc), the tag will automatically be written.

# Audio System

---

## MP3 or WMA Navigation

MP3 tracks may be recorded on the CD in several ways. They can all be placed in the root directory like a conventional audio CD, or they can be placed in folders that may represent, for example, an album, artist, or genre.

The normal playing sequence on CDs with multiple folders is:

- Play the tracks within the root (top level) first
- Then the tracks in any folder(s) within the root
- Then move onto the second folder, and so forth.

To navigate to a track.

1. Press the up or down arrow buttons to enter the track list.
2. Navigate the hierarchy using the arrow buttons to select another folder or track (file).
3. Press **OK** to select a highlighted track.

## MP3 and WMA Display Options

When an MP3 or WMA disc is playing, certain information encoded in each track can be displayed. Such information will normally include:

- The file name.
- The folder name.
- ID3 information which might be the album or artist's name.

The unit will normally show the file name that is playing. To select one of the other items of information, press the **INFO** button repeatedly until the required item is shown in the display.

**Note:** If the ID3 information selected is unavailable, **NO MP3** or **WMA TAG** will be shown in the display.

## CD Text Display Options

When an audio disc with CD text is playing, limited information encoded in each track can be displayed. Such information will normally include:

- The disc name.
- The artist name.
- The track name.

**Note:** These display options are selected in the same way as MP3 displays. **NO DISC NAME** or **NO TRACK NAME** will be shown in the display if no information has been encoded.

## Ending Compact Disc Playback

To restore radio reception on all units, press the **RADIO** button.

**Note:** The CD will not be ejected. The disc will pause at the point where radio reception was restored.

To resume CD playback, press the **CD** button again.

## COMPACT DISC PLAYER - VEHICLES WITH: AM/FM/CD/BLUETOOTH/SONY AM/FM/CD

### Compact Disc Playback

**Note:** During playback, the display indicates the disc, track and time that has elapsed since the start of the track.

During radio reception, press the **CD** button once to start CD playback.

After a disc is loaded, playback will start immediately.



# Audio System

---

## Track Selection

- Press the seek down button once to replay the current track. If pressed within two seconds of the start of a track, the previous track will be selected.
- Press the up or down arrow buttons to select the required track, then press the **OK** button.

The desired track number may be entered using the numeric keypad. Dial the required track number until complete (for example 1 then 2 for track 12), or dial the number and directly press **OK**.

## Fast Forward and Reverse

Press and hold the seek down or up buttons to search backward or forward within the tracks on the disc.

## Shuffle and Random

Random track playback, also known as shuffle, plays all tracks on the CD in random order.

Press function button 2.

**Note:** *When an MP3 CD is playing, options include shuffle for the whole CD, or to play all the tracks in the folder in a random order. Repeat presses of function button 2 will toggle these options.*

Use the seek up or down button to select the next track to shuffle if required.

## Repeat Compact Disc Tracks

Press function button 1.

When an MP3 or WMA CD is playing, options include **REPEAT** for the track, or to repeat all the tracks in the folder. Repeat presses of function button 1 will toggle these options.

## Compact Disc Track Scanning

1. Press **function button 3**.

**Note:** *When an MP3 or WMA CD is playing, options include SCAN for the CD, or just the tracks in the folder. Repeat presses of function button 3 will toggle these options.*

2. Press function button 3 again to stop the scan mode.

## MP3 and WMA File Playback

MP3 (MPEG 1 Audio Layer-3) or WMA (Windows media audio) is a standard technology and format for compressing audio data. This allows a more efficient use of the media.

You can play MP3 files recorded on CD-ROM, CD-R and CD-RW formats. The disc must be in the ISO 9660 level 1 or level 2 format, or Joliet or Romeo in the expansion format. You can also use a disc recorded in multi session.

## ISO 9660 Format

This is the most common international standard for the logical format of files and folders on a CD-ROM.

There are several specification levels. In Level 1, file names must be in the 8.3 format (no more than eight characters in the name, no more than three characters in the extension .MP3 and . WMA) and in capital letters.

Folder names can be no longer than eight characters. There can be no more than eight folder levels (trees). Level 2 specifications allow file names up to 31 characters long.

Each folder can have up to eight trees.

For Joliet or Romeo in the expansion format, consider these restrictions when configuring your CD writing software.

# Audio System

## Multi Session

This is a recording method that enables adding of data using the track-at-once method.

Conventional CDs begin at a CD control area called the lead-in and end at an area called lead-out. A multi session CD is a CD having multiple sessions, with each segment from lead-in to lead-out regarded as a single session.

CD-Extra: The format that records audio (audio CD data) as tracks on session 1, and records data as tracks on session 2.

Mixed CD: In this format, data is recorded as track 1 and audio (audio CD data) is recorded as track 2.

## File Formats

With formats other than ISO 9660 level 1 and level 2, folder names or file names may not be displayed correctly.

When naming, be sure to add the file extension .MP3 or .WMA to the file name.

If you put the extension .MP3 or .WMA to a file other than MP3 or WMA, the unit cannot recognise the file correctly and will generate random noise that could damage your speakers.

The following discs take a longer time to start playback.

- A disc recorded with complicated tree structure.
- A disc recorded in multi session.
- A non-finalised disc to which data can be added.

## Playing a Multi Session Disc

When the first track of the first session is audio CD data only, the audio CD data of the first session is played back. Non-audio CD data, MP3 or WMA file information (track number, time, etc.) is displayed with no sound.

When the first track of the first session is not audio CD data:

- If an MP3 or WMA file is on the disc, only MP3, WMA or other data is skipped. Audio CD data is not recognised.
- If no MP3 or WMA file is in the disc, nothing is played back. Audio CD data is not recognised.

## MP3 and WMA Files Playback Order

The playback order of the folders and files are as shown.

**Note:** A folder that does not include an MP3 or WMA file is skipped.

To specify a desired playback order before the folder or file name. Input the order by number (e.g., 01, 02) then record contents onto a disc. The order differs depending on the writing software.

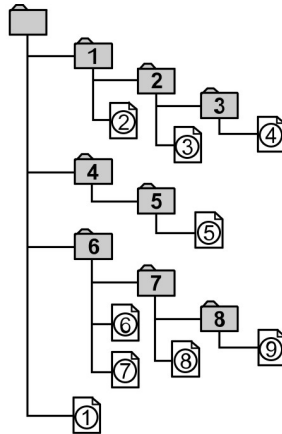

E104206

## ID3 Tag Version 2

The following occurs when an MP3 or WMA file containing a tag is played:

# Audio System

---

- When skipping a portion of a tag (at the beginning of the track) there is no sound output. Skip time changes depending the tag capacity. Example: At 64 kbytes, it is about 2 seconds (with RealJukebox).
- The displayed elapsed playing time when skipping a portion of the tag is inaccurate. For MP3 files of a bit rate other than 128 kbps, time is not displayed accurately during playback.
- When an MP3 file is created with MP3 conversion software (e.g. RealJukebox - a registered trademark of RealNetworks Inc), the tag will automatically be written.

## MP3 or WMA Navigation

MP3 tracks may be recorded on the CD in several ways. They can all be placed in the root directory like a conventional audio CD, or they can be placed in folders that may represent, for example, an album, artist, or genre.

The normal playing sequence on CDs with multiple folders is:

- Play the tracks within the root (top level) first
- Then the tracks in any folder(s) within the root
- Then move onto the second folder, and so forth.

To navigate to a track.

1. Press the up or down arrow buttons to enter the track list.
2. Navigate the hierarchy using the arrow buttons to select another folder or track (file).
3. Press **OK** to select a highlighted track.

## MP3 and WMA Display Options

When an MP3 or WMA disc is playing, certain information encoded in each track can be displayed. Such information will normally include:

- The file name.
- The folder name.
- ID3 information which might be the album or artist's name.

The unit will normally show the file name that is playing. To select one of the other items of information, press the **INFO** button repeatedly until the required item is shown in the display.

**Note:** *If the ID3 information selected is unavailable, **NO MP3** or **WMA TAG** will be shown in the display.*

## CD Text Display Options

When an audio disc with CD text is playing, limited information encoded in each track can be displayed. Such information will normally include:

- The disc name.
- The artist name.
- The track name.

**Note:** *These display options are selected in the same way as MP3 displays. **NO DISC NAME** or **NO TRACK NAME** will be shown in the display if no information has been encoded.*

## Ending Compact Disc Playback

To restore radio reception on all units, press the **RADIO** button.

**Note:** *The CD will not be ejected. The disc will pause at the point where radio reception was restored.*

To resume CD playback, press the **CD** button again.

# Audio System

---

## AUXILIARY INPUT SOCKET

### WARNINGS



Driving while distracted can result in loss of vehicle control, accident and injury. We strongly recommend that you use extreme caution when using any device or feature that may take your focus off the road. Your primary responsibility is the safe operation of your vehicle. We recommend against the use of any handheld device while driving and encourage the use of voice-operated systems when possible. Make sure you are aware of all applicable local laws that may affect the use of electronic devices while driving.



For safety reasons, do not connect or adjust the settings on your portable music player while your vehicle is moving.



Store the portable music player in a secure location, such as the centre console or the glove box, when your vehicle is in moving. Hard objects may become projectiles in a collision or sudden stop, which may increase the risk of serious injury. The audio extension cable must be long enough to allow the portable music player to be safely stored while your vehicle is moving.

---

The auxiliary input jack allows you to connect and play music from your portable music player through your vehicle speakers. You can use any portable music player designed for use with headphones. Your audio extension cable must have male one-eighth inch (three and one-half millimetre) connectors at each end.

1. Make sure your vehicle, radio and portable music player are turned off and move the transmission selector lever to position **P**.
2. Plug the extension cable from the portable music player into the auxiliary input jack.
3. Switch the radio on. Select either a tuned FM station or a CD.
4. Adjust the volume as desired.
5. Switch the portable music player on and adjust its volume to half its maximum level.
6. Press **AUX** until **LINE** or **LINE IN** appears in the display. You should hear music from your device even if it is low.
7. Adjust the volume on your portable music player until it reaches the volume level of the FM station or CD. Do this by switching back and forth between the AUX and FM or CD controls.

# Audio System

---

## AUDIO TROUBLESHOOTING

<b>Audio unit display</b>	<b>Rectification</b>
PLEASE CHECK CD	General error message for CD fault conditions, such as cannot read the CD, data-CD inserted, etc. Make sure the disc is loaded correct way up. Clean and re-try, or replace disc with known music disc. If error persists contact your dealer.
CD DRIVE MALFUNCTION	General error message for CD fault conditions such as possible mechanism fault.
CD DRIVE HIGH TEMP	Ambient temperature too hot – unit will not work until it has cooled down.

# SYNC

## GENERAL INFORMATION

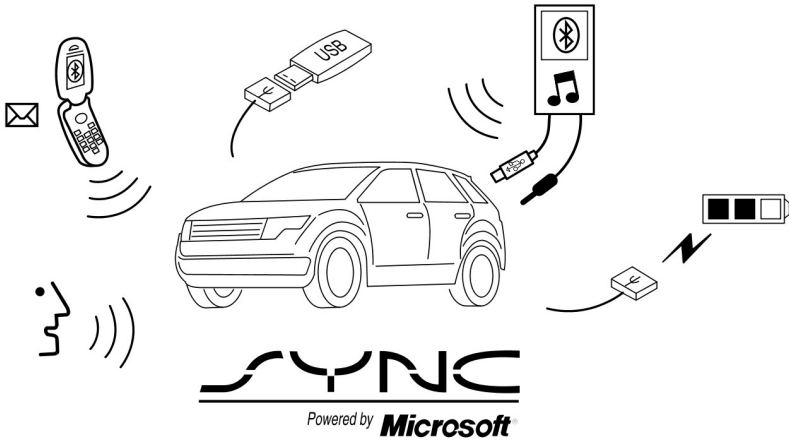

E142598

SYNC is an in-vehicle communications system that works with your Bluetooth-enabled mobile phone and portable media player. This allows you to:

- make and receive calls
- access and play music from your portable music player
- use emergency assistance
- access phonebook contacts and music using voice commands
- stream music from your connected mobile phone
- select pre-defined text messages
- use the advanced voice recognition system
- charge your USB device (if your device supports this).

Make sure that you review your device's user guide before using it with SYNC.

### Support

For further support please contact an authorised dealer. More information is available from the Ford website.

## Safety Information

### WARNING



Driving while distracted can result in loss of vehicle control, collision and injury. We strongly recommend that you use extreme caution when using any device that may take your focus off the road. Your primary responsibility is the safe operation of your vehicle. We recommend against the use of any handheld device while driving, encourage the use of voice-operated systems when possible and that you become aware of applicable country and local laws that may affect use of electronic devices while driving.

---

When using SYNC:

- Do not operate playing devices if the power cords or cables are broken, split or damaged. Carefully place cords and cables where they cannot be stepped on or interfere with the operation of pedals, seats, compartments or safe driving abilities.
- Do not leave playing devices in your vehicle during extreme conditions as it could cause them damage. Refer to your device's user guide for further information.
- Do not attempt to service or repair the system. See an authorised dealer.

## Privacy Information

When a mobile phone is connected to SYNC, the system creates a profile within your vehicle that is linked to that mobile phone. This profile is created in order to offer you more mobile features and to operate more efficiently. Among other things, this profile may contain data about your phone book, text messages (read and unread) and call history. Including the history of calls when your mobile phone was not connected to the system. In addition, if you connect a media device, the system creates and retains an index of supported media content. The system also records a short development log of approximately 10 minutes of all recent system activity. The log profile and other system data may be used to improve the system and help diagnose any problems that may occur.

The mobile phone profile, media device index, and development log will remain in your vehicle unless you delete it and are generally accessible only in your vehicle when the mobile phone or media player is connected. If you no longer plan to use the system or your vehicle, we recommend you perform a master reset to erase all stored information.

System data cannot be accessed without special equipment and access to your vehicle's SYNC module. We will not access the system data for any purpose other than as described absent consent, a court order, or where required by law enforcement, other government authorities or other third parties acting with lawful authority. Other parties may seek to access the information independently of us. For further privacy information, see the sections on emergency assistance.

# SYNC

## USING VOICE RECOGNITION

This system helps you control many features using voice commands. This allows you to keep your hands on the wheel and focus on what is in front of you.

### Helpful Hints

Make sure the interior of your vehicle is as quiet as possible. Wind noise from open windows and road vibrations may prevent the system from correctly recognising spoken commands.

Press the voice button and wait until the system voice announcement has finished followed by a single beep before giving a command. Any command spoken prior to this does not register with the system.

Speak naturally, without long pauses between words.

You can interrupt the system at anytime while it is speaking by pressing the voice icon. You can also cancel a voice session by pressing and holding the voice icon at any time.

### Initiating a Voice Session



Press the voice button and wait until the system voice announcement has finished followed by a single beep. A list of available commands will appear in the display. Say any of the following:

Say	If You Want To
"Bluetooth Audio"	Stream audio from your mobile phone.
"Cancel"	Cancel the requested action.
"Line in"	Access the device connected to the auxiliary input jack.
"Phone"	Make calls.
"SYNC"	Return to the main menu.
"USB"	Access the device connected to your USB port.
"Voice settings"	Adjust the level of voice interaction and feedback.
"Help"	Hear a list of voice commands available in the current mode.

### System Interaction and Feedback

The system provides feedback through audible tones, prompts, questions and spoken confirmations depending on the situation and the chosen level of interaction (voice settings). You can customise the voice recognition system to provide more or less instruction and feedback.

The default setting is to a higher level of interaction in order to help you learn to use the system. You can change these settings at any time.

### Adjusting the Interaction Level



Press the voice button. Say "Voice settings" when prompted, then any of the following:



# SYNC

<b>When You Say</b>	<b>The System</b>
"Interaction Mode Advanced"	Provides less audible interaction and more tone prompts.
"Interaction Mode Standard"	Provides more detailed interaction and guidance.

The system defaults to the standard interaction mode.

Confirmation prompts are short questions the system asks when it is not sure of your request or when there are multiple possible responses to your request. For example, the system may ask "Phone, is that correct?".

Press the voice button to change the confirmation prompts setting. Say "Voice settings" when prompted, then any of the following:

<b>When You Say</b>	<b>The System</b>
"Confirmation Prompts Off"	Makes a best guess from the command. You may still occasionally be asked to confirm settings.
"Confirmation Prompts On"	Clarifies your voice command with a short question.

The system creates candidate lists when it has the same confidence level of several options based on your voice command. When turned on, you may be prompted with as many as four possibilities for clarification.

For example say, "1" after the tone to call John Doe at home or "2" after the tone to call Johnny Doe on mobile or "3" after the tone to call Jane Doe at home.

The same logic applies to media content. For example say: "1" after the tone to play John Doe or "2" after the tone to play Johnny Doe or "3" after the tone to play Jane Doe.

# SYNC

When You Say	The System
"Media Candidate Lists Off"	Makes a best guess from the media candidate list. You may still occasionally be asked questions.
"Media Candidate Lists On"	Clarifies your voice command for media candidates.
"Phone Candidate Lists Off"	Makes a best guess from the mobile phone candidate list. You may still occasionally be asked questions.
"Phone Candidate Lists On"	Clarifies your voice command for mobile phone candidates

## Changing the Voice Settings Using the Information and Entertainment Display

1. Press the **MENU** button.
2. Select **SYNC-Settings**.
3. Select **Voice Settings**.

## USING SYNC® WITH YOUR PHONE

Hands-free calling is one of the main features of SYNC. While the system supports a variety of features, many are dependent on your mobile phone's functionality. At a minimum, most mobile phones with Bluetooth wireless technology support the following functions:

- Answering an incoming call.
- Ending a call.
- Using privacy mode.
- Dialling a number.
- Redialling.
- Call waiting notification.
- Caller ID.

Other features such as text messaging using Bluetooth and automatic phonebook download are mobile phone-dependent features. To check your mobile phone's compatibility, refer to your mobile phone's user manual or visit the regional Ford website.

## Pairing a Mobile Phone For the First Time

**Note:** *You must switch the ignition and radio on.*

**Note:** *To scroll through the menus, press the up and down arrows on your audio system.*

Wirelessly pairing your mobile phone with SYNC allows you to make and receive hands-free calls.

1. Press the **PHONE** button. When the display indicates **No phones paired**, press the **Add button**.
2. When **Please begin pairing by** appears in the display, search for SYNC on your device to start the pairing process. Make sure the Bluetooth feature on your mobile phone is switched on before starting the search. Refer to your mobile phone's user guide if necessary.

# SYNC

3. When prompted on your mobile phone's display, enter the six-digit PIN provided by SYNC in the display. The display indicates when the pairing is successful

Depending on your mobile phone's capability and your market, the system may prompt you with questions such as setting the current mobile phone as the primary phone (the mobile phone SYNC automatically tries to connect with first upon vehicle start-up), downloading your mobile phone book, etc.

## Pairing Subsequent Mobile Phones

**Note:** Make sure the radio is switched on.

**Note:** To scroll through the menus, press the up and down arrows on your audio system.

1. Press the **PHONE** button.

2. Scroll to and select **BT Devices**.
3. Press the **OK** button.
4. Press the **Add button** to start the pairing process.
5. When **Please begin pairing by** appears in the display, search for SYNC on your device to start the pairing process. Refer to your mobile phone's user guide if necessary.
6. When prompted on your mobile phone's display, enter the six-digit PIN provided by SYNC in the audio display. The display indicates when the pairing is successful.

The system then prompts with questions such as would you like to set the current mobile phone as the primary mobile phone (the mobile phone SYNC automatically tries to connect with first upon vehicle start-up), download your mobile phone book, etc.

## Mobile Phone Voice Commands

"PHONE"	
"Call <name>" <sup>1</sup>	"Go to privacy"
"Call <name> at home" <sup>1</sup>	"Hold"
"Call <name> at work" <sup>1</sup>	"Join"
"Call <name> in office" <sup>1</sup>	"Menu" <sup>2,4</sup>
"Call <name> on cell" <sup>1</sup>	"Phonebook <name>" <sup>2</sup>
"Call <name> on other" <sup>1</sup>	"Phonebook <name> at home" <sup>2</sup>
"Call history incoming" <sup>2</sup>	"Phonebook <name> in office" <sup>2</sup>
"Call history missed" <sup>2</sup>	"Phonebook <name> at work" <sup>2</sup>
"Call history outgoing" <sup>2</sup>	"Phonebook <name> on cell" <sup>2</sup>

# SYNC

"PHONE"	
"Connections" <sup>1,2</sup>	"Phonebook <name> on other" <sup>2</sup>
"Dial" <sup>1,3</sup>	-

<sup>1</sup> These commands do not require you to say "Phone" first.

<sup>2</sup> These commands are not available until your mobile phone information has completely downloaded using Bluetooth.

<sup>3</sup> See **Dial** table.

<sup>4</sup> See **Menu** table.

Phonebook commands. When you ask SYNC to access a mobile phone book name, number, etc, the requested information appears in the display to view. Press the **Phone button** and say "call" to call the contact.

"DIAL"
"112" (one-one-two), etc.
"700" (seven hundred)
"800" (eight hundred)
"900" (nine hundred)
"Pound", (#)
"Number <0-9>"
"Asterisk" (*)
"Clear" (deletes all entered digits)
"Delete" (deletes one digit)
"Plus"
"Star"

**Note:** To exit dial mode, press and hold the **phone button**, press **MENU** or any other button.

# SYNC

"MENU"
"(Phone) connections"
"(Phone) settings (message) notification off"
"(Phone) settings (message) notification on"
"(Phone) settings (set) phone ringer"
"(Phone) settings (set) ringer 1"
"(Phone) settings (set) ringer 2"
"(Phone) settings (set) ringer 3"
"(Phone) settings (set) ringer off"
"Phone name"
"Text message inbox"
Words in ( ) are optional and do not have to be spoken for the system to understand the command.

## Making Calls

Press the **voice button** and when prompted say:

1. "Call <name>" or "Dial", then say the number.
2. When the system confirms the number, say "Dial" again to initiate the call.

To erase the last spoken digit, say "Delete" or press the left arrow button. To erase all spoken digits, say "Clear" or press and hold the left arrow button.

To end the call, press the **End Call** button on the steering wheel or select **End Call** on the display and press **OK**.

## Receiving Calls

When receiving a call, you can:

- Answer the call by pressing the **Accept Call** button on the steering wheel or select Accept Call on the display and press **OK**.
- To reject the call press the **Reject Call** button on the steering wheel or select on the display and press **OK**.
- Ignore the call by doing nothing.

## Mobile Phone Options During an Active Call

During an active call, you have additional menu features which become available such as putting a call on hold, joining calls, etc.

To access choose one of the options available at the bottom of the display or press **More**.

# SYNC

When You Select	You Can
Mic. off	Turns your vehicle's microphone off. To turn the microphone on, press the Mic off button again.
Privacy	Switch a call from an active hands-free environment to your mobile phone for a more private conversation. When selected, <b>Privacy</b> will be shown in the display.
Hold	Put an active call on hold. When selected, <b>Hold</b> will be shown in the display.
Dial a number	Enter numbers, for example numbers for passwords using the system keypad.
Join Calls	Join two separate calls. (SYNC supports a maximum of three callers on a multi-party or conference call.) 1. Press <b>More</b> . 2. Access the desired contact through SYNC or use voice commands to place the second call. Once actively in the second call, press the <b>More</b> button. 3. Scroll until <b>Join Calls</b> appears and press <b>OK</b> .
Phonebook	Access your phonebook contacts. 1. Press <b>More</b> . 2. Scroll until <b>Phonebook</b> appears and press <b>OK</b> . 3. Scroll through your phonebook contacts. 2. Press <b>OK</b> again when the desired selection appears in the display. 3. Press the <b>OK</b> or <b>Dial</b> button to call the selection.
Call History	Access your call history log. 1. Press <b>More</b> . 2. Scroll until <b>Call history</b> appears and press <b>OK</b> . 3. Scroll through your call history options (incoming, outgoing or missed). 4. Press <b>OK</b> when the desired selection appears in the display. 5. Press the <b>OK</b> or <b>Dial</b> button to call the selection.

## Accessing Features through the Mobile Phone Menu

You can access your call history, phonebook, sent text messages as well as access mobile phone and system settings. You can also access advanced features such as emergency assistance.

1. Press the **PHONE** button to enter the mobile phone menu.
2. Select one of the options available.

# SYNC

When You Select	You Can
Dial a number	Dial a number using the system keypad.
Redial	Redial the last number called (if available). Press <b>OK</b> to select.
Phonebook <sup>12</sup>	Allows you to access your downloaded phonebook. 1. Press <b>OK</b> to confirm and enter. You can use the buttons at the bottom of the screen to quickly access an alphabetical category. You can also use the letters on the keypad to jump in the list. 2. Scroll until the desired contact appears, then press <b>OK</b> . 3. Press <b>OK</b> or the <b>Dial</b> button to call the desired selection.
Call History <sup>1</sup>	Allows you to access any previously dialled, received or missed calls. 1. Press <b>OK</b> to select. 2. Scroll to select from Incoming calls, Outgoing calls or Missed calls. Press <b>OK</b> make your selection. 3. Press <b>OK</b> or the <b>Dial</b> button to call the desired selection. The system attempts to automatically re-download your phonebook and call history each time your mobile phone connects to SYNC (if the auto download feature is on and your Bluetooth-enabled mobile phone supports this feature).
Speed Dial	Select one of ten speed dial entries. To set a speed dial entry go to the phonebook and press and hold one of the numbers between 0 and 9 on the system keypad.
Text message <sup>1</sup>	Allows you to send, download and delete text messages.
BT Devices	Access <b>Bluetooth Devices</b> menu listings (add, connect, set as primary, on or off, delete).
Phone settings <sup>1</sup>	Allows you to view your mobile phone's status, set ring tones, select your message notification, change phonebook entries, automatically download your mobile phone's phonebook, and any other features on your mobile phone.
Emergency Assistance	Allows you to turn the emergency assistance feature on or off.

<sup>1</sup> This is a mobile phone dependent feature.

## Text Messaging

**Note:** *This is a mobile phone dependent feature.*

SYNC allows you to receive, send, download and delete text messages. The system can also read incoming text messages to you so that you do not have to take your eyes off the road.

### Receiving a Text Message

**Note:** *This is a mobile phone dependent feature. Your mobile phone must support downloading text messages using Bluetooth to receive incoming text messages.*

**Note:** *Only one recipient is allowed per text message.*

When a new message arrives, an audible tone sounds and the display indicates you have a new message. You have these options:

- Press the **Listen** button to have SYNC read the message to you.
- Press **View** to open the text message, press ignore or do nothing and the message goes into your text message inbox. Once pressed, you have the ability to have the message read out to you, to view other messages or to select **More**.
- Open a voice session and say "Read text message"
- Select more and scroll. Choose between:
  - **Reply to sender:** Press **OK** to access and then scroll through the list of pre-defined messages to send.
  - **Call sender:** Press **OK** to call the sender of the message.
  - **Forward msg:** Press **OK** to forward the message to anyone in your phonebook or call history. You can also choose to enter a number.

## Sending, Downloading and Deleting Your Text Messages

Text messaging is a mobile phone dependent feature. If your mobile phone is compatible, SYNC allows you to receive, send, download and delete text messages.

1. Press the **PHONE** button.
2. Scroll until **Text messaging** appears, then press **OK**.

A list of all available text messages appears. You can choose from the following options:

- **New** enables you to send a new text message based on a pre-defined set of 15 messages.
- **View** allows you to read the full message and in addition provides the option to get the message read out to you by SYNC. To go to the next message select **More** this allows you to reply to the sender, call the sender or forward the message.
- **Delete** allows you to delete current text messages from SYNC (not your mobile phone). The display indicates when all your text messages have been deleted by showing **Empty** in the display.
- **More** allows you to delete all messages or to manually trigger a download of all unread messages from your mobile phone.

When you select **Send Text Message** you have the following choices of pre-defined messages:

- Can't talk now.
- Call you later.
- Heavy traffic :-).
- See u in 10 min.
- See u in 20 min.
- Yes.
- No.



# SYNC

- Thanks!.
- Too funny :-).
- Miss you.
- I love you.
- Send directions.
- Call me.
- Where are you?
- Why?

To send the message:

1. Press **Send** when the desired selection is highlighted in the display.
2. Press **Yes** when the contact appears and press **OK** again to confirm when the system asks if you would like to send the message. Each text message is sent with the following signature:  
This message was sent from my Ford.

**Note:** You can send text messages either by choosing a contact from the phonebook and selecting the text option from the display or by replying to a received message in the inbox.

## Accessing Your Mobile Phone Settings

These are mobile phone dependent features. Your mobile phone settings allow you to access and adjust features such as your ring tone, text message notification, modify your phonebook and also set up automatic download.

1. Press the **PHONE** button.
2. Scroll until **Phone Settings** appears, then press **OK**.
3. Scroll to select from the following options:

When You Select	You Can
Set as master	If this option is checked, SYNC will use this mobile phone as the master when there is more than one mobile phone available within your vehicle that is paired to SYNC. This option can be changed for all paired mobile phones (not only for the active one) using the <b>BT Devices</b> menu.
Phone Status	See the mobile phone name, provider name, mobile phone number, signal level and battery level. Providing your mobile phone supports this feature. When done, press the left <b>arrow</b> to return to the mobile phone status menu.
Set ringtone	Select which ring tone sounds during an incoming call (one of the system's or your mobile phone's). 1. Press <b>OK</b> to select and scroll to hear <b>Ringtone 1, Ringtone 2, Ringtone 3</b> and <b>Phone ringtone</b> . 2. Press <b>OK</b> to select. If your mobile phone supports in-band ringing, your mobile phone's ringer sounds when <b>Phone ringtone</b> is chosen.
Text msg notify	Have the option of hearing an audible tone to notify you when a text message arrives.

# SYNC

When You Select	You Can
	1. Press <b>OK</b> to turn on or off the audible tone.
Phonebook pref.	<p>Modify the contents of your phonebook (i.e. add, delete, download). Press <b>OK</b> to select and scroll between:</p> <p><b>Add contacts:</b> Press <b>OK</b> to add more contacts from your phonebook. Push the desired contact(s) on your mobile phone. Refer to your mobile phone's user guide on how to push contacts.</p> <p><b>Delete:</b> Press <b>OK</b> to delete the current phonebook and call history. When <b>Delete phonebook?</b> appears, press <b>Yes</b> to confirm. SYNC takes you back to the <b>Phone Settings</b> menu.</p> <p><b>Download now:</b> Press <b>OK</b> to select and download your phonebook to SYNC.</p> <p><b>Auto-download:</b> Check or uncheck this option to automatically download your phonebook each time your mobile phone connects to SYNC. Downloading times are mobile phone dependent and quantity dependent.</p> <p>When auto download is switched on, any changes, additions or deletions saved in SYNC since your last download are deleted.</p> <p>To not download your phonebook every time your mobile phone connects to SYNC select off.</p> <p>Your phonebook, call history and text messages can only be accessed when your paired mobile phone is connected to SYNC.</p>

## BT Devices

This menu provides access to your bluetooth devices. Use the arrow buttons to scroll through the menu options.

The **BT Devices** menu allows you to add, connect and delete devices and set a mobile phone as primary.

## Bluetooth Devices Menu Options

1. Press the **PHONE** button to enter the **mobile phone menu**.
2. Scroll until **BT Devices** appears, then press **OK**.
3. Scroll to select from the following options:

If You Select	You Can
Add	Pair additional mobile phones to the system. 1. Press <b>Add button</b> to start the pairing process.

# SYNC

If You Select	You Can
	<p>2. When <b>Please begin pairing by</b> appears in the display, search for <b>SYNC</b> on your device to start the pairing process. Refer to your mobile phone's user guide if necessary.</p> <p>3. When prompted on your mobile phone's display, enter the six-digit PIN provided by SYNC in the radio display. The display indicates when the pairing is successful.</p> <p>4. Set <b>phone name</b> as the favorite mobile phone? Choose between Yes and No.</p> <p>5. Depending on the functionality of your mobile phone, you may be asked additional questions (i.e. if you would like to download your phonebook). Press <b>Yes</b> or <b>No</b> to select your responses.</p>
Delete	<p>Delete a paired mobile phone. Press <b>Delete</b> and confirm with <b>Yes</b> when asked to delete the selected device from SYNC. After deleting a mobile phone from the list, the mobile phone can only be connected again by executing the pairing process.</p>
Master	<p>Set a previously paired mobile phone as your primary mobile phone. Press <b>Master</b> to select the desired mobile phone as the primary mobile phone. SYNC attempts to connect with the primary mobile phone every time the ignition is switched on. When a mobile phone is selected as primary, it appears first in the list and is marked with an asterisk*</p>
Conn.	<p>Connect a previously paired bluetooth-enabled mobile phone. You can only have one device connected at a time to use the mobile phone functionality. When another mobile phone is connected, the previous mobile phone will be disconnected for the telephone services. SYNC allows you to use different Bluetooth devices for the mobile phone functionality and the BT Audio music playback feature at the same time. Press <b>Conn.</b> to connect to the selected previously paired mobile phone.</p>
Discon.	<p>Disconnects the selected mobile phone. Press <b>Discon.</b> and confirm with <b>Yes</b> when asked. After disconnecting a mobile phone, it can be connected again without performing the full pairing process.</p>

# SYNC

## System Settings

system's menu.

1. Press the **MENU** button to enter the
2. Select **SYNC-Settings**, then press **OK**.

If You Select	You Can
Bluetooth on	Check or uncheck this option to turn on or off the Bluetooth interface of the system. Select, then press <b>OK</b> to change the option's status.
Set defaults	Return to the factory default settings. This selection does not erase your indexed information (phonebook, call history, text messages and paired devices). Press <b>OK</b> to select and then press <b>Yes</b> when <b>Set defaults?</b> appears in the display.
Master reset	Completely erase all information stored on SYNC (phonebook, call history, text messages and paired devices) and return to the factory default settings. Press <b>OK</b> to select and then press <b>Yes</b> when <b>Master reset?</b> appears in the display. The display indicates when complete and SYNC takes you back to the <b>SYNC-Settings</b> menu.
Install on SYNC	Install applications or software updates you have downloaded. Scroll to select and then press <b>OK</b> . Confirm with <b>Yes</b> when <b>Install on SYNC</b> appears in the display. There must be a valid SYNC application or update available on the USB thumb drive in order to finish an installation successfully.
System info	Display the system's version numbers as well as its serial number. Press <b>OK</b> to select.
Voice settings	The voice settings submenu contains Interact. mode, Confirm prompt, mobile Phone candidate and Media candidate. See <b>Using Voice Recognition</b> (page 198).
Browse USB	Browse the actual menu structure of the connected USB device. Press <b>OK</b> and use the up or down arrows to scroll the folders and files. Use the left or right arrows to enter and leave a folder. Media content can be directly selected for playback from this menu.
Emergency assistance	You can turn the emergency assistance feature on or off. See <b>SYNC® Applications and Services</b> (page 211).

## SYNC® APPLICATIONS AND SERVICES

1. Press the **MENU** button to enter the system's menu.
2. Scroll until **SYNC-Apps** is selected, then press **OK**.

A list of available applications will be shown. Each application might have its own specific settings.

## SYNC Emergency Assistance

### WARNINGS



For this feature to work, your mobile phone must be compatible with SYNC.



Always place your mobile phone in a secure location inside your vehicle. Failure to do so may cause serious injury to someone or damage the phone which could prevent emergency assistance from working correctly.



Unless the emergency assistance setting is set to on prior to a collision, the system will not attempt to place an emergency call which could delay the response time, potentially increasing the risk of serious injury or death. Do not wait for emergency assistance to make an emergency call if you can do it yourself. Dial emergency services immediately to avoid a delayed response time. If you do not hear emergency assistance within five seconds of the collision, the system or mobile phone may be damaged or non functional.

**Note:** Before selecting this feature, you must read the emergency assistance privacy notice later in this section for important information.

**Note:** When you turn emergency assistance on or off, that setting will apply for all paired mobile phones. If you have turned emergency assistance off and a previously paired phone connects when you switch the ignition on, either a voice message plays, a display message or icon is shown or both.

**Note:** Every mobile phone operates differently. While SYNC emergency assistance works with most mobile phones, some mobile phones may experience difficulties using this feature.

**Note:** For important information regarding airbag deployment: See **Supplementary Restraints System** (page 22).

In the event of a collision which deploys an airbag or activates the fuel cut-off switch, the system may contact emergency services by dialling 112 (the wireless emergency number that works in most European countries) through a paired and connected mobile phone. For more information about SYNC and emergency assistance visit your regional Ford website.

## Setting Emergency Assistance On:

1. Press the **PHONE** button to enter the mobile Phone menu.
2. Scroll to **emergency assistance**.
3. Press **OK** to confirm and enter the emergency assistance menu.
4. Scroll through and highlight the **On** or **Off** selection.
5. Press **OK** to confirm the selection.

Display options:

- In case **On** was selected, **Set On** appears in the display as confirmation.
- In case **Off** was selected a dialogue appears which allows you to set a voice reminder.

# SYNC

---

- Off with voice reminder provides a display and voice reminder when the mobile phone connects and your vehicle starts.
- Off without voice reminder provides a display reminder only without a voice reminder when the mobile phone connects.

## **To Make Sure That Emergency Assistance Works Correctly:**

- SYNC must have power and be working correctly at the time of the collision and during feature activation and use.
- The emergency assistance feature must be set to on prior to the incident.
- You must have a mobile phone connected to SYNC.
- In certain countries it may be necessary to have a valid and registered SIM card with credit in order to place and maintain a 112 call.
- A connected mobile phone must have the ability to make and maintain an outgoing call at the time of the incident.
- A connected mobile phone must have adequate network coverage, battery power and signal strength.
- Your vehicle must have battery power and be located in a European country or region where SYNC emergency assistance can call the local emergency services. See your regional Ford website for details.

## **In the Event of a Collision**

**Note:** *Not every collision will deploy an airbag or activate the fuel cut-off switch (which may activate emergency assistance). However, if emergency assistance is triggered, SYNC tries to contact the emergency services. If a connected mobile phone is damaged or loses connection to SYNC, SYNC searches for and tries to connect to, any available previously paired mobile phone and will attempt to make an emergency call to 112.*

Before making a call:

- If the call has not been cancelled and a successful call is made, the introductory message is played first for the emergency operator, followed by hands-free communication between your vehicle occupant and the operator.
- SYNC provides a short window of time (approximately 10 seconds) to cancel the call. If the call is not cancelled SYNC will attempt to dial 112.
- SYNC says the following, or a similar message: "SYNC will attempt to make an emergency call. To cancel the call, please choose cancel from the screen or press the hang up button".

During a call

- Emergency assistance uses vehicle GPS or mobile network information when available to determine the most appropriate language to alert the emergency operator of the collision and deliver the introductory message. Which may include your vehicles GPS coordinates.
- The language used to interact with your vehicle occupants is pre-selected by the user for all SYNC functions and may differ from the language used by SYNC to deliver information to the Emergency Operator.

# SYNC

---

- After the delivery of the introductory message the voice line will open so that you can speak hands-free with the emergency operator.
- When the line is connected, you must be prepared to provide your name, phone number and location information immediately.

**Note:** *While information is being provided to the emergency operator you will hear the following or similar message "Please stand by while important information is being delivered to the emergency operator." SYNC will say "line open" or similar at the start of hands-free communication.*

**Note:** *During an emergency assistance call, an emergency priority screen will be displayed in your vehicle which contains vehicle GPS coordinates when available. These coordinates match the information provided to the emergency operator in the introductory message.*

**Note:** *The emergency operator may also receive information from the mobile network such as mobile phone number, mobile phone location and mobile phone carrier name independent from SYNC emergency assistance.*

Emergency assistance may not work if:

- Your mobile phone or emergency assistance hardware has been damaged in a collision.
- Your vehicle's battery or the SYNC system has no power.
- If your phone is thrown from your vehicle during a collision.
- You do not have a valid and registered SIM card with credit in your phone.
- You are in a European country or region where the SYNC emergency assistance call cannot be placed. See your regional Ford website for details.

## **Important Information About the Ford SYNC Emergency Assistance Feature**

Emergency Assistance does not currently call emergency services in the following markets: Albania, Belarus, Bosnia and Herzegovina, Macedonia, Netherlands, Ukraine, Moldova and Russia.

See your regional Ford website for latest details.

## **Emergency Assistance Privacy Notice**

Once emergency assistance is set to on, it may disclose to emergency services that your vehicle has been in a collision involving the deployment of an airbag or activation of the fuel cut-off switch. This feature has the capability to disclose your location information to the emergency operator or other details about your vehicle or collision to provide the most appropriate emergency services.

If you do not want to disclose this information, do not turn the feature on.

## **USING SYNC® WITH YOUR MEDIA PLAYER**

You can access and play music from your digital music player over your vehicle's speaker system using the system's media menu or voice commands. You can also sort and play your music by specific categories such as artists, albums, etc.

SYNC is capable of hosting nearly any digital media player including: iPod®, Zune™, Plays from device players, and most USB drives. SYNC also supports audio formats such as MP3, WMA, WAV and ACC.

# SYNC

## Connecting Your Digital Media Player to the USB Port

**Note:** If your digital media player has a power switch, make sure that the device is turned on.

### To Connect Using Voice Commands

1. Plug the device into your vehicle's USB port.
2. Press the voice button and when prompted, say "USB".
3. You can now play music by saying any of the appropriate voice commands. Refer to the media voice commands.

### To Connect Using the System Menu

1. Plug the device into your vehicle's USB port.
2. Press the **AUX** button until **initialising** appears in the top left corner of the display.
3. Depending on how many digital media files are on your connected device, **Indexing USB** may appear in the display. When indexing is complete, the screen returns to the **Play** menu.

Press **Browse**. Now you can scroll through the list:

- **Play all.**
- **Playlists.**
- **Songs.**
- **Artists.**
- **Albums.**
- **Genres.**
- **Browse USB.**
- **Reset USB.**
- **Exit.**

## What's Playing?

At any time when a track is playing, you can press the voice icon and ask the system "What's playing?" The system reads the metadata tags (if populated) of the track being played.

## Media Voice Commands



Press the voice button and when prompted say "USB", and then any of the following:

"USB"	
"Pause"	
"Play"	"Repeat off"
"Play album <name>" <sup>1,2</sup>	"Repeat on"
"Play All"	"Search album <name>" <sup>1,2</sup>
"Play artist <name>" <sup>1,2</sup>	"Search artist <name>" <sup>1,2</sup>
"Play genre <name>" <sup>1,2</sup>	"Search genre <name>" <sup>1</sup>
"Play next folder" <sup>3</sup>	"Search song <name>" <sup>1</sup>
"Play next track"	"Search track <name>" <sup>1,2</sup>



# SYNC

"USB"	
"Play playlist <name>" <sup>1,2</sup>	"Shuffle off"
"Play previous folder" <sup>3</sup>	"Shuffle on"
"Play previous track"	"Similar music"
"Play song <name>" <sup>1</sup>	"What's playing?"
"Play track <name>" <sup>1,2</sup>	

<sup>1</sup> <name> is a dynamic listing, meaning that it could be the name of any desired group, artist, song, etc.

<sup>2</sup> Voice commands which are not available until indexing is complete.

<sup>3</sup> Voice commands which are only available in folder mode.

Voice Command Guide	
"Search genre" or "Play genre"	The system searches all the data from your indexed music and if available, begins to play the chosen type of music. You can only play genres of music which are present in the genre metadata tags that you have on your digital media player.
"Similar music"	The system compiles a playlist and then plays similar music to what is currently playing from the USB port using indexed metadata information.
Search or Play, "Artist", "Track, or "Album"	The system searches for a specific artist, track or album from the music indexed through the USB port.

The system is also capable of playing music from your mobile phone via Bluetooth.

To switch the Bluetooth audio on use the **AUX** or **Source** button or press the voice button and when prompted say "Bluetooth audio", then any of the following:

# SYNC

<b>"BLUETOOTH AUDIO"</b>
"Connections"
"Pause"
"Play"
"Play next track"
"Play previous track"

## Media Menu Features

The media menu allows you to select how to play your music (by artist, genre, shuffle, repeat, etc.) and to find similar music or reset the index of your USB devices.

1. Press **AUX** to select USB playback and then **Options** to enter the **Media** menu.
2. Scroll to cycle through:

<b>When You Select</b>	<b>You Can</b>
Shuffle playlist and Repeat track	Choose to shuffle or repeat your music. Once these selections are turned on, they will remain on until switched off.
Similar music	You can play similar types of music to the current playlist from the USB port. The system uses the metadata information of each song to compile a playlist. The system then creates a new list of similar songs and will then begin playing. Each track must have the metadata tags populated for this feature. With certain playing devices, if your metadata tags are not populated, the tracks will not be available in voice recognition, play menu or similar music. However, if you place these tracks onto your playing device in mass storage device mode they are available in voice recognition, Play menu browsing and Similar Music. Unknowns are placed into any unpopulated metadata tag.
Reset SYNC USB	Resets the USB index. After the new indexing is complete you can choose what to play from the USB song library.

# SYNC

## Accessing Your USB Song Library

This menu allows you to select and play your media by artist, album, genre, playlist, track or even to browse what is on your USB device.

1. Make sure that your device is plugged into the USB port and is turned on.

2. Press **AUX** to select USB playback and then **Browse**.

If there are no media files to access, the display indicates there is no media. If there are media files, you have the following options to scroll through and select from:

When You Select	You Can
Play all	Play all indexed media (tracks) from your playing device one at a time in numerical order. . Press <b>OK</b> to select. The first track title appears in the display.
Playlists	Access your playlists (from formats such as . ASX, .M3U, . WPL or . MTP). . 1. Press <b>OK</b> to select. 2. Scroll to select the desired playlist, then press <b>OK</b> .
Songs	Search for and play a specific track which has been indexed. . 1. Press <b>OK</b> to select. 2. Scroll to select the desired track, then press <b>OK</b> .
Artists	Sort all indexed media by artist. Once selected, the system lists and then plays all artists and tracks alphabetically. . 1. Press <b>OK</b> to select. 2. Scroll to select the desired artist, then press <b>OK</b> .
Albums	Sort all indexed media by albums. . 1. Press <b>OK</b> to select. 2. Scroll to select the desired albums, then press <b>OK</b> .
Genres	Sort indexed music by genre (category) type. . 1. Press <b>OK</b> to select. 2. Scroll to select the desired genre, then press <b>OK</b> .
Browse USB	Browse all supported digital media on your media device connected to the USB port. You can only view media content which is compatible with SYNC, other files saved are not visible. 1. Press <b>OK</b> to select.

# SYNC

When You Select	You Can
	2. Scroll to browse indexed media on your flash drive, then press <b>OK</b> .
Reset USB	Resets the USB index. After the new indexing is complete you can choose what to play from the USB song library.

You can use the buttons at the bottom of the screen to quickly jump to a certain alphabetical category. You can also use the letters on you're the number pad to jump in the list.

## Bluetooth Devices and System Settings

You can access these menus using the display. See **Using SYNC® With Your Phone** (page 200).

## SYNC® TROUBLESHOOTING

Your SYNC system is easy to use. However, should questions arise, please refer to the tables below.

Use the Ford website to check your mobile phone's compatibility.

Phone Issues		
Issue	Possible Cause	Possible Solution
A lot of background noise during a phone call.	The audio control settings on your phone may be affecting SYNC performance.	Review your phone's user guide regarding audio adjustments.
During a call, I can hear the other person but they cannot hear me.	Possible phone malfunction.	Try turning off the device, resetting the device, removing the device's battery, then trying again. Make sure that the <b>Mic off</b> option of SYNC is set to off.
SYNC is not able to download my phonebook.	This is a phone-dependent feature. Possible phone malfunction.	Go to the website to review your phone's compatibility. Try turning off the device, resetting the device or removing the device's battery, then trying again. Try pushing your phonebook contacts to SYNC by using the <b>Add contacts</b> feature. You must switch your mobile phone on and the automatic phonebook download feature on SYNC.

# SYNC

Phone Issues		
Issue	Possible Cause	Possible Solution
The system says "Phonebook downloaded" but my phonebook in SYNC is empty or is missing contacts.	Limitations on your phone's capability.	Try pushing your phonebook contacts to SYNC by using the <b>Add contacts</b> feature. If the missing contacts are stored on your SIM card, try moving them to the device memory. Remove any pictures or special ring tones associated with the missing contact. You must switch your mobile phone on and the automatic phonebook download feature on SYNC.
I'm having trouble connecting my mobile phone to SYNC.	This is a mobile phone-dependent feature. Possible mobile phone malfunction.	Go to the website to review your mobile phone's compatibility. Try turning off the device, resetting the device or removing the device's battery, then trying again. Try deleting your device from SYNC, deleting SYNC from your device and trying again. Always check the security and auto accept prompt settings relative to the SYNC Bluetooth connection on your mobile phone. Update your device's firmware. Turn off the <b>Auto phonebook download</b> setting.
Text messaging is not working on SYNC.	This is a mobile phone-dependent feature. Possible mobile phone malfunction.	Go to the website to review your mobile phone's compatibility. Try turning off the device, resetting the device or removing the device's battery, then trying again.
Audible SMS text messages do not work on my mobile phone.	This is a mobile phone limitation.	This is a mobile phone-dependent feature. Your mobile phone must support downloading text messages via Bluetooth to receive incoming text messages. Access the text messaging menu of SYNC to see if the feature is supported by your mobile phone. Press the <b>PHONE</b> button and then scroll and select <b>Text messaging</b> , then press <b>OK</b> .

# SYNC

<b>Phone Issues</b>		
<b>Issue</b>	<b>Possible Cause</b>	<b>Possible Solution</b>
		Because each mobile phone is different refer to the mobile phone's user's guide for the specific mobile phone being paired. In fact, there can be differences between mobile phones due to brand, model, service provider and software version.

<b>USB and Media Issues</b>		
<b>Issue</b>	<b>Possible Cause</b>	<b>Possible Solution</b>
I'm having trouble connecting my device.	Possible device malfunction.	Try turning off the device, resetting the device, removing the device's battery, then trying again. Make sure you are using the manufacturer's cable. Make sure the USB cable is correctly inserted into the device and your vehicle's USB port. Make sure that the device does not have an auto-install program or active security settings.
SYNC does not recognise my device when I start my vehicle.	This is a device limitation.	Make sure you are not leaving the device in your vehicle during very hot or cold temperatures.
Bluetooth audio does not stream.	This is a mobile phone-dependent feature. The device is not connected.	Make sure the device is connected to SYNC and that you have pressed play on your device.
SYNC does not recognise music that is on my device.	Your music files may not contain the correct artist, song title, album or genre information.	Make sure that all song details are populated.

# SYNC

<b>USB and Media Issues</b>		
<b>Issue</b>	<b>Possible Cause</b>	<b>Possible Solution</b>
	The file may be corrupted. The song may have copyright protection which does not allow it to play.	Some devices require you to change the USB settings from mass storage to media transfer protocol class.
When my iPhone or iPod Touch is connected via the USB and Bluetooth Audio at the same time, I sometimes do not hear any sound.	This is a device limitation.	From the iPhone or iPod Touch music now playing screen, select the audio device airplay icon at the very bottom of your iPhone or iPod Touch screen. To listen to the iPhone or iPod Touch via Bluetooth Audio, select SYNC. To listen to the iPhone or iPod Touch via USB, select Dock Connector.

<b>Voice Command Issues</b>		
<b>Issue</b>	<b>Possible Cause</b>	<b>Possible Solution</b>
SYNC does not understand what I am saying.	You may be using the wrong voice commands. You may be speaking too soon or at the wrong time.	Review the mobile phone voice commands and the media voice commands at the beginning of their respective sections. Refer to the screen during an active voice session, you will find a list of voice commands there. The microphone for the system is either in your rear view mirror or in the headliner just above the windshield.
SYNC does not understand the name of a song or artist.	You may be using the wrong voice commands. You may not be saying the name exactly as it is saved. The system may not be reading the name the same way you are saying it.	Review the media voice commands at the beginning of the media section. Say the song or artist exactly as they are listed. If you say "Play Artist Prince" the system does not play music by Prince and the Revolution or Prince and the New Power Generation. Make sure you are saying the complete title such as "California remix featuring Jennifer Nettles".

# SYNC

Voice Command Issues		
Issue	Possible Cause	Possible Solution
		<p>If the songs are saved in capital letters, you have to spell them. LOLA requires you to say "L-O-L-A".</p> <p>Do not use special characters in the title as the system does not recognise them.</p>
<p>SYNC does not understand or is calling the wrong contact when I want to make a call.</p>	<p>You may be using the wrong voice commands. You may not be saying the name exactly as it is saved.</p> <p>Contacts in your phonebook may be very short and similar, or they may contain special characters.</p> <p>Your phonebook contacts may be saved in capital letters.</p>	<p>Review the mobile phone voice commands at the beginning of the mobile phone section.</p> <p>Make sure you are saying the contacts exactly as they are listed. For example, if a contact is saved as Joe Wilson, say "Call Joe Wilson".</p> <p>The system works better if you list full names such as "Joe Wilson" rather than "Joe".</p> <p>Do not use special characters such as 123 or ICE as the system does not recognise them.</p> <p>If contacts are saved in capital letters, you have to spell them. JAKE requires you to say "Call J-A-K-E".</p> <p>You can also use the mobile phone and media candidate lists to get a list of possible candidates when the system did not fully understand you. See <b>Using Voice Recognition</b> (page 198).</p>
<p>The SYNC voice control system is having trouble recognising foreign names stored in my mobile phone book contact list.</p>	<p>Foreign names are spoken using the currently selected language for SYNC.</p>	<p>The SYNC system applies the phonetic pronunciation rules of the selected language to the contact names stored on your mobile phone.</p> <p>Helpful Hint: Select your contact manually (<b>PHONE</b> &gt; <b>Phonebook</b> &gt; <b>contact name</b>) and press the <b>Hear It</b> soft-key. SYNC will read the contact name to you, giving you some idea of the pronunciation SYNC is expecting.</p>



# SYNC

<b>Voice Command Issues</b>		
<b>Issue</b>	<b>Possible Cause</b>	<b>Possible Solution</b>
The SYNC voice control system is having trouble recognising foreign tracks, artists, albums, genres and playlist names from my USB media player or USB flash drive.	Foreign names are spoken using the currently selected language for SYNC.	The SYNC system applies the phonetic pronunciation rules of the selected language to the names stored on your USB media player or USB flash drive. The system is able to make some exceptions for very popular artist names (e.g. U2) such that you can always use the English pronunciation for these artists.
Voice prompts are electronically generated, and the pronunciation of some words may not be accurate for my language.	The SYNC system uses text-to-speech voice prompt technology.	The system uses a synthetically-generated voice rather than pre-recorded human voice. SYNC offers several new voice control features for a wide range of languages. Dialling a contact name directly from the phonebook without pre-recording (e.g. "call John Smith") or selecting a track, artist, album, genre or playlist directly from your USB media player (e.g. "play artist Madonna).
My previous bluetooth voice control system allowed me to control the radio, CD, and climate control systems. Why can I not control these systems with SYNC?	The focus of SYNC is controlling your mobile devices and the content stored on your devices.	SYNC offers significant capability above and beyond the previous system such as. Dialling a contact name directly from the phonebook without pre-recording (e.g. "call John Smith") or selecting a track, artist, album, genre or playlist directly from your USB media player (e.g. "play artist Madonna).

# SYNC

<b>General</b>		
<b>Issue</b>	<b>Possible Cause</b>	<b>Possible Solution</b>
The language selected for the instrument cluster and information and entertainment display (radio, CD, menu settings, etc.) does not match the SYNC language (phone, USB, Bluetooth audio, voice control and voice prompts).	A language not supported by SYNC is currently selected for the instrument cluster and information and entertainment display.	SYNC only supports four languages in a single module for text display, voice control and voice prompts. The four languages in each bundle are selected based upon the most popular languages spoken in the country where your vehicle is sold. If the selected language is not available, SYNC will remain in the current active language. SYNC offers several new voice control features for a wide range of languages. Dialling a contact name directly from the phonebook without pre-recording (e.g. "call John Smith") or selecting a track, artist, album, genre or playlist directly from your USB media player (e.g. play artist Madonna).





# Appendices

## ELECTROMAGNETIC COMPATIBILITY

### WARNINGS

 Your vehicle has been tested and certified to legislations relating to electromagnetic compatibility (72/245/EEC, UN ECE Regulation 10 or other applicable local requirements). It is your responsibility to make sure that any equipment you have fitted complies with applicable local legislations. Have any equipment fitted by an authorised dealer.

### WARNINGS

-  The radio frequency transmitter equipment (e.g. mobile telephones, amateur radio transmitters etc.) may only be fitted to your vehicle if they keep to the parameters shown in the table below. There are no special provisions or conditions for installations or use.
-  Do not mount any transceiver, microphones, speakers, or any other item in the deployment path of the airbag system.
-  Do not fasten antenna cables to original vehicle wiring, fuel pipes and brake pipes.
-  Keep antenna and power cables at least 4 inches (10 centimetres) from any electronic modules and airbags.

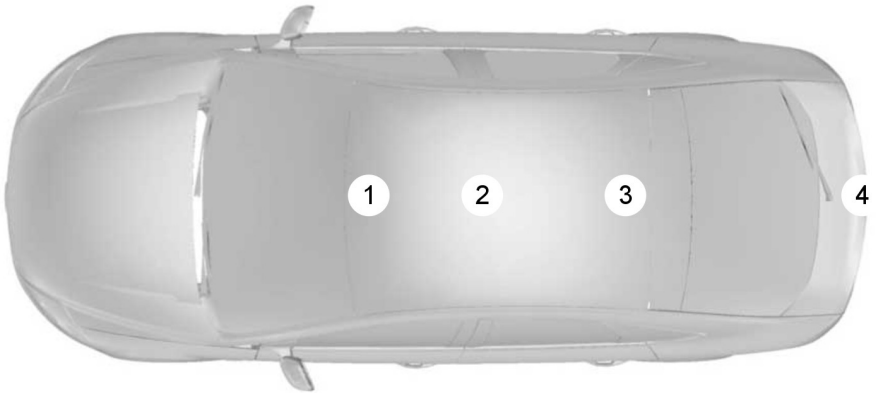

E85998

Frequency Band MHz	Maximum output power Watt (Peak RMS)	Antenna Positions
1 – 30	50 W	3, 4
30 – 54	50 W	1, 2, 3
68 – 87.5	50 W	1, 2, 3

# Appendices

Frequency Band MHz	Maximum output power Watt (Peak RMS)	Antenna Positions
142 – 176	50 W	1, 2, 3
380 – 512	50 W	1, 2, 3
806 – 940	10 W	1, 2, 3
1200 – 1400	10 W	1, 2, 3
1710 – 1885	10 W	1, 2, 3
1885 – 2025	10 W	1, 2, 3

**Note:** After the installation of radio frequency transmitters, check for disturbances from and to all electrical equipment in your vehicle, both in the standby and transmit modes.

Check all electrical equipment:

- with the ignition ON
- with the engine running
- during a road test at various speeds.

Check that electromagnetic fields generated inside your vehicle cabin by the transmitter installed do not exceed applicable human exposure requirements.

## END USER LICENCE AGREEMENT

### SYNC® End User Licence Agreement (EULA)

- You have acquired a device ("DEVICE") that includes software licenced by FORD MOTOR COMPANY from an affiliate of Microsoft Corporation ("MS"). Those installed software products of MS origin, as well as associated media, printed materials,

and "online" or electronic documentation ("MS SOFTWARE") are protected by international intellectual property laws and treaties. The MS SOFTWARE is licenced, not sold. All rights reserved.

- The MS SOFTWARE may interface with and/or communicate with, or may be later upgraded to interface with and/or communicate with additional software and/or systems provided by FORD MOTOR COMPANY. The additional software and systems of FORD MOTOR COMPANY origin, as well as associated media, printed materials, and "online" or electronic documentation ("FORD SOFTWARE") are protected by international intellectual property laws and treaties. The FORD SOFTWARE is licenced, not sold. All rights reserved.

# Appendices

---

- The MS SOFTWARE and/or FORD SOFTWARE may interface with and/or communicate with, or may be later upgraded to interface with and/or communicate with additional software and/or systems provided by third party software and service suppliers. The additional software and services of third party origin, as well as associated media, printed materials, and "online" or electronic documentation ("THIRD PARTY SOFTWARE") are protected by international intellectual property laws and treaties. The THIRD PARTY SOFTWARE is licenced, not sold. All rights reserved.
- The MS SOFTWARE, FORD SOFTWARE and THIRD PARTY SOFTWARE hereinafter collectively and individually will be referred to as "SOFTWARE".

**IF YOU DO NOT AGREE TO THIS END USER LICENCE AGREEMENT ("EULA") DO NOT USE THE DEVICE OR COPY THE SOFTWARE. ANY USE OF THE SOFTWARE, INCLUDING BUT NOT LIMITED TO USE ON THE DEVICE, WILL CONSTITUTE YOUR AGREEMENT TO THIS EULA (OR RATIFICATION OF ANY PREVIOUS CONSENT).**

**GRANT OF SOFTWARE LICENCE:** This EULA grants you the following licence:

- You may use the SOFTWARE as installed on the DEVICE and as otherwise interfacing with systems and/or services provide by or through FORD MOTOR COMPANY or its third party software and service providers.
- Description of Other Rights and Limitations**
- **Speech Recognition:** If the SOFTWARE includes speech recognition component(s), you should understand that speech recognition is an inherently statistical process and that recognition errors are inherent in the process. Neither FORD MOTOR COMPANY nor its suppliers shall be liable for any damages arising out of errors in the speech recognition process.
  - **Limitations on Reverse Engineering, Decompilation and Disassembly:** You may not reverse engineer, decompile, or disassemble nor permit others to reverse engineer, decompile or disassemble the SOFTWARE, except and only to the extent that such activity is expressly permitted by applicable law notwithstanding this limitation.
  - **Limitations on Distributing, Copying, Modifying and Creating Derivative Works:** You may not distribute, copy, make modifications to or create derivative works based on the SOFTWARE, except and only to the extent that such activity is expressly permitted by applicable law notwithstanding this limitation.
  - **Single EULA:** The end user documentation for the DEVICE and related systems and services may contain multiple EULAs, such as multiple translations and/or multiple media versions (e.g., in the user documentation and in the software). Even if you receive multiple EULAs, you are licenced to use only one (1) copy of the SOFTWARE.

## Appendices

---

- **SOFTWARE Transfer:** You may permanently transfer your rights under this EULA only as part of a sale or transfer of the DEVICE, provided you retain no copies, you transfer all of the SOFTWARE (including all component parts, the media and printed materials, any upgrades, and, if applicable, the Certificate(s) of Authenticity), and the recipient agrees to the terms of this EULA. If the SOFTWARE is an upgrade, any transfer must include all prior versions of the SOFTWARE.
- **Termination:** Without prejudice to any other rights, FORD MOTOR COMPANY or MS may terminate this EULA if you fail to comply with the terms and conditions of this EULA.
- **Security Updates/Digital Rights Management:** Content owners use the WMDRM technology included in your DEVICE to protect their intellectual property, included copyrighted content. Portions of the SOFTWARE on your DEVICE use WMDRM software to access WMDRM-protected content. If the WMDRM software fails to protect the content, content owners may ask Microsoft to revoke the SOFTWARE's ability to use WMDRM to play or copy protected content. This action does not affect unprotected content. When your DEVICE downloads licences for protected content, you agree that Microsoft may include a revocation list with the licences. Content owners may require you to upgrade the SOFTWARE on your DEVICE to access their content. If you decline an upgrade, you will not be able to access content that requires the upgrade.
- **Consent to Use of Data:** You agree that MS, Microsoft Corporation, FORD MOTOR COMPANY, third party software and systems suppliers, their affiliates and/or their designated agent may collect and use technical information gathered in any manner as part of product support services related to the SOFTWARE or related services. MS, Microsoft Corporation, FORD MOTOR COMPANY, third party software and services suppliers, their affiliates and/or their designated agent may use this information solely to improve their products or to provide customized services or technologies to you. MS, Microsoft Corporation, FORD MOTOR COMPANY, third party software and systems suppliers, their affiliates and/or their designated agent may disclose this information to others, but not in a form that personally identifies you.
- **Internet-Based Services Components:** The SOFTWARE may contain components that enable and facilitate the use of certain Internet-based services. You acknowledge and agree that MS, Microsoft Corporation, FORD MOTOR COMPANY, third party software and service suppliers, their affiliates and/or their designated agent may automatically check the version of the SOFTWARE and/or its components that you are utilizing and may provide upgrades or supplements to the SOFTWARE that may be automatically downloaded to your DEVICE.
- **Additional Software/Services:** The SOFTWARE may permit FORD MOTOR COMPANY, third party software and service suppliers, MS, Microsoft Corporation, their affiliates and/or their designated agent to provide or make available to you SOFTWARE updates,

## Appendices

---

supplements, add-on components, or Internet-based services components of the SOFTWARE after the date you obtain your initial copy of the SOFTWARE ("Supplemental Components").

If FORD MOTOR COMPANY or third party software and services suppliers provide or make available to you Supplemental Components and no other EULA terms are provided along with the Supplemental Components, then the terms of this EULA shall apply.

If MS, Microsoft Corporation, their affiliates and/or their designated agent make available Supplemental Components, and no other EULA terms are provided, then the terms of this EULA shall apply, except that the MS, Microsoft Corporation or affiliate entity providing the Supplemental Component(s) shall be the licensor of the Supplemental Component(s).

FORD MOTOR COMPANY, MS, Microsoft Corporation, their affiliates and/or their designated agent reserve the right to discontinue without liability any Internet-based services provided to you or made available to you through the use of the SOFTWARE.

- **Links to Third Party Sites:** The MS SOFTWARE may provide you with the ability to link to third party sites through the use of the SOFTWARE. The third party sites are not under the control of MS, Microsoft Corporation, their affiliates and/or their designated agent. Neither MS nor Microsoft Corporation nor their affiliates nor their designated agent are responsible for (i) the contents of any third party sites, any links contained in third party sites, or any changes or updates to third party sites, or (ii) webcasting or any other form of transmission received from any third party sites. If the SOFTWARE provides links to third party sites, those links are provided to you only as a convenience, and the inclusion of any link does not imply an endorsement of the third party site by MS, Microsoft Corporation, their affiliates and/or their designated agent.

- **Obligation to Drive Responsibly:** You recognise your obligation to drive responsibly and keep attention on the road. You will read and abide with the DEVICE operating instructions particularly as they pertain to safety and assumes any risk associated with the use of the DEVICE.

**UPGRADES AND RECOVERY MEDIA:** If the SOFTWARE is provided by FORD MOTOR COMPANY separate from the DEVICE on media such as a ROM chip, CD ROM disk(s) or via web download or other means, and is labelled "For Upgrade Purposes Only" or "For Recovery Purposes Only" you may install one (1) copy of such SOFTWARE onto the DEVICE as a replacement copy for the existing SOFTWARE, and use it in accordance with this EULA, including any additional EULA terms accompanying the upgrade SOFTWARE.

# Appendices

---

## **INTELLECTUAL PROPERTY RIGHTS:**

All title and intellectual property rights in and to the SOFTWARE (including but not limited to any images, photographs, animations, video, audio, music, text and "applets" incorporated into the SOFTWARE), the accompanying printed materials, and any copies of the SOFTWARE, are owned by MS, Microsoft Corporation, FORD MOTOR COMPANY, or their affiliates or suppliers. The SOFTWARE is licenced, not sold. You may not copy the printed materials accompanying the SOFTWARE. All title and intellectual property rights in and to the content which may be accessed through use of the SOFTWARE is the property of the respective content owner and may be protected by applicable copyright or other intellectual property laws and treaties. This EULA grants you no rights to use such content. All rights not specifically granted under this EULA are reserved by MS, Microsoft Corporation, FORD MOTOR COMPANY, third party software and service providers, their affiliates and suppliers. Use of any on-line services which may be accessed through the SOFTWARE may be governed by the respective terms of use relating to such services. If this SOFTWARE contains documentation that is provided only in electronic form, you may print one copy of such electronic documentation.

**EXPORT RESTRICTIONS:** You acknowledge that the SOFTWARE is subject to U.S. and European Union export jurisdiction. You agree to comply with all applicable international and national laws that apply to the SOFTWARE, including the U.S. Export Administration Regulations, as well as end-user, end-use and destination restrictions issued by U.S. and other governments. For additional information, see <http://www.microsoft.com/exporting/>.

**TRADEMARKS:** This EULA does not grant you any rights in connection with any trademarks or service marks of FORD MOTOR COMPANY, MS, Microsoft Corporation, third party software or service providers, their affiliates or suppliers.

**PRODUCT SUPPORT:** Product support for the SOFTWARE is not provided by MS, its parent corporation Microsoft Corporation, or their affiliates or subsidiaries. For product support, please refer to FORD MOTOR COMPANY instructions provided in the documentation for the DEVICE. Should you have any questions concerning this EULA, or if you desire to contact FORD MOTOR COMPANY for any other reason, please refer to the address provided in the documentation for the DEVICE.

## **No Liability for Certain Damages:**

EXCEPT AS PROHIBITED BY LAW, FORD MOTOR COMPANY, ANY THIRD PARTY SOFTWARE OR SERVICES SUPPLIERS, MS, MICROSOFT CORPORATION AND THEIR AFFILIATES SHALL HAVE NO LIABILITY FOR ANY INDIRECT, SPECIAL, CONSEQUENTIAL OR INCIDENTAL DAMAGES ARISING FROM OR IN CONNECTION WITH THE USE OR PERFORMANCE OF THE SOFTWARE. THIS LIMITATION SHALL APPLY EVEN IF ANY REMEDY FAILS OF ITS ESSENTIAL PURPOSE. IN NO EVENT SHALL MS, MICROSOFT CORPORATION AND/OR THEIR AFFILIATES BE LIABLE FOR ANY AMOUNT IN EXCESS OF U.S. TWO HUNDRED FIFTY DOLLARS (U.S. \$250.00).

- THERE ARE NO WARRANTIES OTHER THAN THOSE THAT MAY EXPRESSLY BE PROVIDED FOR YOUR NEW VEHICLE.



# Appendices

---

## End User Notice

### **Microsoft® Windows® Mobile for Automotive Important Safety Information**

This system Ford SYNC™ contains software that is licenced to Manufacturer FORD MOTOR COMPANY by an affiliate of Microsoft Corporation pursuant to a licence agreement. Any removal, reproduction, reverse engineering or other unauthorised use of the software from this system in violation of the licence agreement is strictly prohibited and may subject you to legal action.

**Read and follow instructions:** Before using your Windows Automotive-based system, read and follow all instructions and safety information provided in this end user manual ("User's Guide"). Not following precautions found in this User's Guide can lead to an accident or other serious consequences.

**Keep User's Guide in vehicle:** When kept in the vehicle, the User's Guide will be a ready reference for you and other users unfamiliar with the Windows Automotive-based system. Please make certain that before using the system for the first time, all persons have access to the User's Guide and read its instructions and safety information carefully.

## WARNING



Operating certain parts of this system while driving can distract your attention away from the road, and possibly cause an accident or other serious consequences. Do not change system settings or enter data non-verbally (using your hands) while driving. Stop the vehicle in a safe and legal manner before attempting these operations. This is important since while setting up or changing some functions you might be required to distract your attention away from the road and remove your hands from the wheel.

### **General Operation**

**Voice Command Control:** Functions within the Windows Automotive-based system may be accomplished using only voice commands. Using voice commands while driving allows you to operate the system without removing your hands from the wheel.

**Prolonged Views of Screen:** Do not access any function requiring a prolonged view of the screen while you are driving. Pull over in a safe and legal manner before attempting to access a function of the system requiring prolonged attention. Even occasional short scans to the screen may be hazardous if your attention has been diverted away from your driving task at a critical time.

**Volume Setting:** Do not raise the volume excessively. Keep the volume at a level where you can still hear outside traffic and emergency signals while driving. Driving while unable to hear these sounds could cause an accident.

## Appendices

---

### **Use of Speech Recognition Functions:**

Speech recognition software is inherently a statistical process which is subject to errors. It is your responsibility to monitor any speech recognition functions included in the system and address any errors.

**Navigation Features:** Any navigation features included in the system are intended to provide turn by turn instructions to get you to a desired destination. Please make certain all persons using this system carefully read and follow instructions and safety information fully.

**Distraction Hazard:** Any navigation features may require manual (non-verbal) setup. Attempting to perform such set-up or insert data while driving can seriously distract your attention and could cause an accident or other serious consequences. Stop the vehicle in a safe and legal manner before attempting these operations.

**Let Your Judgment Prevail:** Any navigation features are provided only as an aid. Make your driving decisions based on your observations of local conditions and existing traffic regulations. Any such feature is not a substitute for your personal judgment. Any route suggestions made by this system should never replace any local traffic regulations or your personal judgment or knowledge of safe driving practices.

**Route Safety:** Do not follow the route suggestions if doing so would result in an unsafe or illegal manoeuver, if you would be placed in an unsafe situation, or if you would be directed into an area that you consider unsafe. The driver is ultimately responsible for the safe operation of the vehicle and therefore, must evaluate whether it is safe to follow the suggested directions.

**Potential Map Inaccuracy:** Maps used by this system may be inaccurate because of changes in roads, traffic controls or driving conditions. Always use good judgment and common sense when following the suggested routes.

**Emergency Services:** Do not rely on any navigation features included in the system to route you to emergency services. Ask local authorities or an emergency services operator for these locations. Not all emergency services such as police, fire stations, hospitals and clinics are likely to be contained in the map database for such navigation features.

### **TeleNav Software End User Licence Agreement**

Please read these terms and conditions carefully before you use the TeleNav Software. Your use of the TeleNav Software indicates that you accept these terms and conditions. If you do not accept these terms and conditions, do not break the seal of the package, launch, or otherwise use the TeleNav Software.

TeleNav may revise this Agreement and the privacy policy at any time, with or without notice to you. You agree to visit <http://www.telenav.com> from time to time to review the then current version of this Agreement and of the privacy policy.

# Appendices

---

## **1. Safe and Lawful Use**

You acknowledge that devoting attention to the TeleNav Software may pose a risk of injury or death to you and others in situations that otherwise require your undivided attention, and you therefore agree to comply with the following when using the TeleNav Software: (a) observe all traffic laws and otherwise drive safely; (b) use your own personal judgment while driving. If you feel that a route suggested by the TeleNav Software instructs you to perform an unsafe or illegal manoeuvre, places you in an unsafe situation, or directs you into an area that you consider to be unsafe, do not follow such instructions; (c) do not input destinations, or otherwise manipulate the TeleNav Software, unless your vehicle is stationary and parked; (d) do not use the TeleNav Software for any illegal, unauthorised, unintended, unsafe, hazardous, or unlawful purposes, or in any manner inconsistent with this Agreement; (e) arrange all GPS and wireless devices and cables necessary for use of the TeleNav Software in a secure manner in your vehicle so that they will not interfere with your driving and will not prevent the operation of any safety device (such as an airbag).

You agree to indemnify and hold TeleNav harmless against all claims resulting from any dangerous or otherwise inappropriate use of the TeleNav Software in any moving vehicle, including as a result of your failure to comply with the directions above.

## **2. Account Information**

You agree: (a) when registering the TeleNav Software, to provide TeleNav with true, accurate, current, and complete information about yourself, and (b) to inform TeleNav promptly of any changes to such information, and to keep it true, accurate, current and complete.

## **3. Software Licence**

Subject to your compliance with the terms of this Agreement, TeleNav hereby grants to you a personal, non-exclusive, non-transferable licence (except as expressly permitted below in connection with your permanent transfer of the TeleNav Software licence), without the right to sublicense, to use the TeleNav Software (in object code form only) in order to access and use the TeleNav Software. This licence shall terminate upon any termination or expiration of this Agreement. You agree that you will use the TeleNav Software only for your personal business or leisure purposes, and not to provide commercial navigation services to other parties.

## Appendices

---

### **3.1 Licence Limitations**

You agree not to do any of the following: (a) reverse engineer, decompile, disassemble, translate, modify, alter or otherwise change the TeleNav Software or any part thereof; (b) attempt to derive the source code, audio library or structure of the TeleNav Software without the prior express written consent of TeleNav; (c) remove from the TeleNav Software, or alter, any of TeleNav's or its suppliers' trademarks, trade names, logos, patent or copyright notices, or other notices or markings; (d) distribute, sublicense or otherwise transfer the TeleNav Software to others, except as part of your permanent transfer of the TeleNav Software; or (e) use the TeleNav Software in any manner that (i) infringes the intellectual property or proprietary rights, rights of publicity or privacy or other rights of any party, (ii) violates any law, statute, ordinance or regulation, including but not limited to laws and regulations related to spamming, privacy, consumer and child protection, obscenity or defamation, or (iii) is harmful, threatening, abusive, harassing, tortuous, defamatory, vulgar, obscene, libellous, or otherwise objectionable; and (f) lease, rent out, or otherwise permit unauthorised access by third parties to the TeleNav Software without advanced written permission of TeleNav.

### **4. Disclaimers**

To the fullest extent permissible pursuant to applicable law, in no event will TeleNav, its licensors and suppliers, or agents or employees of any of the foregoing, be liable for any decision made or action taken by you or anyone else in reliance on the information provided by the TeleNav Software. TeleNav also does not warrant the accuracy of the map or other data used for the TeleNav Software. Such data may not always reflect reality due to, among other things, road closures, construction, weather, new roads and other changing conditions. You are responsible for the entire risk arising out of your use of the TeleNav Software. For example but without limitation, you agree not to rely on the TeleNav Software for critical navigation in areas where the well-being or survival of you or others is dependent on the accuracy of navigation, as the maps or functionality of the TeleNav Software are not intended to support such high risk applications, especially in more remote geographical areas.

TELENAV EXPRESSLY DISCLAIMS AND EXCLUDES ALL WARRANTIES IN CONNECTION WITH THE TELENAV SOFTWARE, WHETHER STATUTORY, EXPRESS OR IMPLIED, INCLUDING ALL WARRANTIES WHICH MAY ARISE FROM COURSE OF DEALING, CUSTOM OR TRADE AND INCLUDING, BUT NOT LIMITED TO, THE IMPLIED WARRANTIES OF MERCHANTABILITY, FITNESS FOR A PARTICULAR PURPOSE AND NON-INFRINGEMENT OF THIRD PARTY RIGHTS WITH RESPECT TO THE TELENAV SOFTWARE. Certain jurisdictions do not permit the disclaimer of certain warranties, so this limitation may not apply to you.

# Appendices

---

## **5. Limitation of Liability**

TO THE EXTENT PERMITTED UNDER APPLICABLE LAW, UNDER NO CIRCUMSTANCES SHALL TELENAV OR ITS LICENSORS AND SUPPLIERS BE LIABLE TO YOU OR TO ANY THIRD PARTY FOR ANY INDIRECT, INCIDENTAL, CONSEQUENTIAL, SPECIAL OR EXEMPLARY DAMAGES (INCLUDING IN EACH CASE, BUT NOT LIMITED TO, DAMAGES FOR THE INABILITY TO USE THE EQUIPMENT OR ACCESS DATA, LOSS OF DATA, LOSS OF BUSINESS, LOSS OF PROFITS, BUSINESS INTERRUPTION OR THE LIKE) ARISING OUT OF THE USE OF OR INABILITY TO USE THE TELENAV SOFTWARE, EVEN IF TELENAV HAS BEEN ADVISED OF THE POSSIBILITY OF SUCH DAMAGES.

NOTWITHSTANDING ANY DAMAGES THAT YOU MIGHT INCUR FOR ANY REASON WHATSOEVER (INCLUDING, WITHOUT LIMITATION, ALL DAMAGES REFERENCED HEREIN AND ALL DIRECT OR GENERAL DAMAGES IN CONTRACT, TORT (INCLUDING NEGLIGENCE) OR OTHERWISE), THE ENTIRE LIABILITY OF TELENAV AND OF ALL OF TELENAV'S SUPPLIERS SHALL BE LIMITED TO THE AMOUNT ACTUALLY PAID BY YOU FOR THE TELENAV SOFTWARE. SOME STATES AND/OR JURISDICTIONS DO NOT ALLOW THE EXCLUSION OR LIMITATION OF INCIDENTAL OR CONSEQUENTIAL DAMAGES, SO THE ABOVE LIMITATIONS OR EXCLUSIONS MAY NOT APPLY TO YOU.

## **6. Arbitration and Governing Law**

You agree that any dispute, claim or controversy arising out of or relating to this Agreement or the TeleNav Software shall be settled by independent arbitration involving a neutral arbitrator and administered by the American Arbitration Association in the County of Santa Clara, California. The arbitrator shall apply the Commercial Arbitration Rules of the American Arbitration Association, and the judgment upon the award rendered by the arbitrator may be entered by any court having jurisdiction. Note that there is no judge or jury in an arbitration proceeding and the decision of the arbitrator shall be binding upon both parties. You expressly agree to waive your right to a jury trial.

This Agreement and performance hereunder will be governed by and construed in accordance with the laws of the State of California, without giving effect to its conflict of laws provisions. To the extent judicial action is necessary in connection with the binding arbitration, both TeleNav and you agree to submit to the exclusive jurisdiction of the courts of the County of Santa Clara, California. The United Nations Convention on Contracts for the International Sale of Goods shall not apply.

# Appendices

---

## **7. Assignment**

You may not resell, assign, or transfer this Agreement or any of your rights or obligations, except in totality, in connection with your permanent transfer of the TeleNav Software, and expressly conditioned upon the new user of the TeleNav Software agreeing to be bound by the terms and conditions of this Agreement. Any such sale, assignment or transfer that is not expressly permitted under this paragraph will result in immediate termination of this Agreement, without liability to TeleNav, in which case you and all other parties shall immediately cease all use of the TeleNav Software. Notwithstanding the foregoing, TeleNav may assign this Agreement to any other party at any time without notice, provided the assignee remains bound by this Agreement.

## **8. Miscellaneous**

### **8.1**

This Agreement constitutes the entire agreement between TeleNav and you with respect to the subject matter hereof.

### **8.2**

Except for the limited licences expressly granted in this Agreement, TeleNav retains all right, title and interest in and to the TeleNav Software, including without limitation all related intellectual property rights. No licences or other rights which are not expressly granted in this Agreement are intended to, or shall be, granted or conferred by implication, statute, inducement, estoppel or otherwise, and TeleNav and its suppliers and licensors hereby reserve all of their respective rights other than the licences explicitly granted in this Agreement

### **8.3**

By using the TeleNav Software, you consent to receive from TeleNav all communications, including notices, agreements, legally required disclosures or other information in connection with the TeleNav Software (collectively, "Notices") electronically. TeleNav may provide such Notices by posting them on TeleNav's Website or by downloading such Notices to your wireless device. If you desire to withdraw your consent to receive Notices electronically, you must discontinue your use of the TeleNav Software.

### **8.4**

TeleNav's or your failure to require performance of any provision shall not affect that party's right to require performance at any time thereafter, nor shall a waiver of any breach or default of this Agreement constitute a waiver of any subsequent breach or default or a waiver of the provision itself.

### **8.5**

If any provision herein is held unenforceable, then such provision will be modified to reflect the intention of the parties, and the remaining provisions of this Agreement will remain in full force and effect

### **8.6**

The headings in this Agreement are for convenience of reference only, will not be deemed to be a part of this Agreement, and will not be referred to in connection with the construction or interpretation of this Agreement. As used in this Agreement, the words "include" and "including" and variations thereof, will not be deemed to be terms of limitation, but rather will be deemed to be followed by the words "without limitation".

# Appendices

---

## 9. Other Vendors Terms and Conditions

The TeleNav Software utilizes map and other data licenced to TeleNav by third party vendors for the benefit of you and other end users. This Agreement includes end-user terms applicable to these companies (included at the end of this Agreement), and thus your use of the TeleNav Software is also subject to such terms. You agree to comply with the following additional terms and conditions, which are applicable to TeleNav's third party vendor licensors:

### NavTeq End User Licence Agreement

#### END USER TERMS

The content provided ("Data") is licenced, not sold. By opening this package, or installing, copying, or otherwise using the Data, you agree to be bound by the terms of this agreement. If you do not agree to the terms of this agreement, you are not permitted to install, copy, use, resell or transfer the Data. If you wish to reject the terms of this agreement, and have not installed, copied, or used the Data, you must contact your retailer or NAVTEQ North America, LLC ("NT") within thirty (30) days of purchase for a refund of your purchase price. To contact NT, please visit [www.navteq.com](http://www.navteq.com).

The Data is provided for your personal, internal use only and may not be resold. It is protected by copyright, and is subject to the following terms (this "End User Licence Agreement") and conditions which are agreed to by you, on the one hand, and NAVTEQ North America, LLC ("NT") and its licensors (including their licensors and suppliers) on the other hand.

The Data for areas of Canada includes information taken with permission from Canadian authorities, including: © Her Majesty the Queen in Right of Canada, © Queen's Printer for Ontario, © Canada Post Corporation, GeoBase®.

NT holds a nonexclusive licence from the United States Postal Service ® to publish and sell ZIP+4 ® information.

© United States Postal Service ® 2009. Prices are not established, controlled or approved by the United States Postal Service ® The following trademarks and registrations are owned by the USPS: United States Postal Service, USPS, and ZIP+4.

The Data for Mexico includes certain Data from Instituto Nacional de Estadística y Geografía.

#### TERMS AND CONDITIONS

**Licence Limitations on Use:** You agree that your licence to use this Data is limited to and conditioned on use for solely personal, non-commercial purposes, and not for service bureau, timesharing or other similar purposes. Except as otherwise set forth herein, you agree not to otherwise reproduce, copy, modify, decompile, disassemble or reverse engineer any portion of this Data, and may not transfer or distribute it in any form, for any purpose, except to the extent permitted by mandatory laws.

**Licence Limitations on Transfer:** Your limited licence does not allow transfer or resale of the Data, except on the condition that you may transfer the Data and all accompanying materials on a permanent basis if: (a) you retain no copies of the Data; (b) the recipient agrees to the terms of this End User Licence Agreement; and (c) you transfer the Data in the exact same form as you purchased it by physically transferring the original media (e.g., the CD-ROM or DVD you purchased), all original packaging, all Manuals and other documentation. Specifically, Multi-disc sets may only be transferred or sold as a complete set as provided to you and not as a subset thereof.

## Appendices

---

**Additional Licence Limitations:** Except where you have been specifically licenced to do so by NT in a separate written agreement, and without limiting the preceding paragraph, your licence is conditioned on use of the Data as prescribed in this agreement, and you may not (a) use this Data with any products, systems, or applications installed or otherwise connected to or in communication with vehicles capable of vehicle navigation, positioning, dispatch, real time route guidance, fleet management or similar applications; or (b) with, or in communication with, including without limitation, cellular phones, palmtop and handheld computers, pagers, and personal digital assistants or PDAs.

### WARNING



This Data may contain inaccurate or incomplete information due to the passage of time, changing circumstances, sources used and the nature of collecting comprehensive geographic Data, any of which may lead to incorrect results.

**No Warranty:** This Data is provided to you "as is", and you agree to use it at your own risk. NT and its licensors (and their licensors and suppliers) make no guarantees, representations or warranties of any kind, express or implied, arising by law or otherwise, including but not limited to, content, quality, accuracy, completeness, effectiveness, reliability, fitness for a particular purpose, usefulness, use or results to be obtained from this Data, or that the Data or server will be uninterrupted or error free.

**Disclaimer of Warranty:** NT AND ITS LICENSORS (INCLUDING THEIR LICENSORS AND SUPPLIERS) DISCLAIM ANY WARRANTIES, EXPRESS OR IMPLIED, OF QUALITY, PERFORMANCE, MERCHANTABILITY, FITNESS FOR A PARTICULAR PURPOSE OR NON-INFRINGEMENT. Some States, Territories and Countries do not allow certain warranty exclusions, so to that extent the above exclusion may not apply to you.

**Disclaimer of Liability:** NT AND ITS LICENSORS (INCLUDING THEIR LICENSORS AND SUPPLIERS) SHALL NOT BE LIABLE TO YOU IN RESPECT OF ANY CLAIM, DEMAND OR ACTION, IRRESPECTIVE OF THE NATURE OF THE CAUSE OF THE CLAIM, DEMAND OR ACTION ALLEGING ANY LOSS, INJURY OR DAMAGES, DIRECT OR INDIRECT, WHICH MAY RESULT FROM THE USE OR POSSESSION OF THIS DATA; OR FOR ANY LOSS OF PROFIT, REVENUE, CONTRACTS OR SAVINGS, OR ANY OTHER DIRECT, INDIRECT, INCIDENTAL, SPECIAL OR CONSEQUENTIAL DAMAGES ARISING OUT OF YOUR USE OF OR INABILITY TO USE THIS DATA, ANY DEFECT IN THIS DATA, OR THE BREACH OF THESE TERMS OR CONDITIONS, WHETHER IN AN ACTION IN CONTRACT OR TORT OR BASED ON A WARRANTY, EVEN IF NT OR ITS LICENSORS HAVE BEEN ADVISED OF THE POSSIBILITY OF SUCH DAMAGES. Some States, Territories and Countries do not allow certain liability exclusions or damages limitations, so to that extent the above may not apply to you.



# Appendices

---

**Export Control:** You agree not to export from anywhere any part of the Data or any direct product thereof except in compliance with, and with all licences and approvals required under, applicable export laws, rules and regulations, including but not limited to the laws, rules and regulations administered by the Office of Foreign Assets Control of the U.S. Department of Commerce and the Bureau of Industry and Security of the U.S. Department of Commerce. To the extent that any such export laws, rules or regulations prohibit NT from complying with any of its obligations hereunder to deliver or distribute Data, such failure shall be excused and shall not constitute a breach of this Agreement.

**Entire Agreement:** These terms and conditions constitute the entire agreement between NT (and its licensors, including their licensors and suppliers) and you pertaining to the subject matter hereof, and supersedes in their entirety any and all written or oral agreements previously existing between us with respect to such subject matter.

**Severability:** You and NT agree that if any portion of this agreement is found illegal or unenforceable, that portion shall be severed and the remainder of the Agreement shall be given full force and effect.

**Governing Law:** The above terms and conditions shall be governed by the laws of the State of Illinois, without giving effect to (i) its conflict of laws provisions, or (ii) the United Nations Convention for Contracts for the International Sale of Goods, which is explicitly excluded. You agree to submit to the personal jurisdiction of the State of Illinois for any and all disputes, claims and actions arising from or in connection with the Data provided to you hereunder.

**Government End Users:** If the Data is being acquired by or on behalf of the United States government or any other entity seeking or applying rights similar to those customarily claimed by the United States government, this Data is a "commercial term" as that term is defined at 48 C.F.R. ("FAR") 2.101, is licenced in accordance with this End User Licence Agreement, and each copy of Data delivered or otherwise furnished shall be marked and embedded as appropriate with the following "Notice of Use", and be treated in accordance with such Notice:

## NOTICE OF USE

CONTRACTOR  
(MANUFACTURER/SUPPLIER)

NAME:

## NAVTEQ

CONTRACTOR  
(MANUFACTURER/SUPPLIER)

ADDRESS:

**425 West Randolph Street, Chicago, IL 60606.**

This Data is a commercial item as defined in FAR 2.101

and is subject to the End User Licence Agreement under

which this Data was provided.

© 2011 NAVTEQ. All rights reserved.

If the Contracting Officer, federal government agency, or any federal official refuses to use the legend provided herein, the Contracting Officer, federal government agency, or any federal official must notify NAVTEQ prior to seeking additional or alternative rights in the Data.

Wi-Fi hotspot data provided by JiWire, © 2013 JiWire.

# Appendices

---

## **Gracenote® Copyright**

CD and music-related data from Gracenote, Inc., copyright© 2000-2007 Gracenote. Gracenote Software, copyright © 2000-2007 Gracenote. This product and service may practice one or more of the following U.S. Patents #5,987,525, #6,061,680, #6,154,773, #6,161,132, #6,230,192, #6,230,207, #6,240,459, #6,330,593 and other patents issued or pending. Some services supplied under licence from Open Globe, Inc. for U.S. Patent: #6,304,523.

Gracenote and CDDb are registered trademarks of Gracenote. The Gracenote logo and logotype, and the "Powered by Gracenote™" logo are trademarks of Gracenote.

## **Gracenote® End User Licence Agreement (EULA)**

This device contains software from Gracenote, Inc. of 2000 Powell Street Emeryville, California 94608 ("Gracenote").

The software from Gracenote (the "Gracenote Software") enables this device to do disc and music file identification and obtain music-related information, including name, artist, track, and title information ("Gracenote Data") from online servers ("Gracenote Servers"), and to perform other functions. You may use Gracenote Data only by means of the intended End User functions of this device.

This device may contain content belonging to Gracenote's providers. If so, all of the restrictions set forth herein with respect to Gracenote Data shall also apply to such content and such content providers shall be entitled to all of the benefits and protections set forth herein that are available to Gracenote.

You agree that you will use the content from Gracenote ("Gracenote Content"), Gracenote Data, the Gracenote Software, and Gracenote Servers for your own personal, non-commercial use only. You agree not to assign, copy, transfer or transmit the Gracenote Content, Gracenote Software or any Gracenote Data (except in a Tag associated with a music file) to any third party. YOU AGREE NOT TO USE OR EXPLOIT GRACENOTE CONTENT, GRACENOTE DATA, THE GRACENOTE SOFTWARE, OR GRACENOTE SERVERS, EXCEPT AS EXPRESSLY PERMITTED HEREIN.

You agree that your non-exclusive licences to use the Gracenote Content, Gracenote Data, the Gracenote Software, and Gracenote Servers will terminate if you violate these restrictions. If your licences terminate, you agree to cease any and all use of the Gracenote Content, Gracenote Data, the Gracenote Software, and Gracenote Servers. Gracenote, respectively, reserve all rights in Gracenote Data, the Gracenote Software, and the Gracenote Servers and Gracenote Content, including all ownership rights. Under no circumstances will either Gracenote become liable for any payment to you for any information that you provide, including any copyrighted material or music file information. You agree that Gracenote may enforce its respective rights, collectively or separately, under this agreement against you, directly in each company's own name.

Gracenote uses a unique identifier to track queries for statistical purposes. The purpose of a randomly assigned numeric identifier is to allow Gracenote to count queries without knowing anything about who you are. For more information, see the web page at [www.gracenote.com](http://www.gracenote.com) for the Gracenote Privacy Policy.

# Appendices

---

THE GRACENOTE SOFTWARE, EACH ITEM OF GRACENOTE DATA AND THE GRACENOTE CONTENT ARE LICENCED TO YOU "AS IS". NEITHER GRACENOTE MAKES ANY REPRESENTATIONS OR WARRANTIES, EXPRESS OR IMPLIED, REGARDING THE ACCURACY OF ANY GRACENOTE DATA FROM THE GRACENOTE SERVERS OR GRACENOTE CONTENT. GRACENOTE COLLECTIVELY AND SEPARATELY RESERVE THE RIGHT TO DELETE DATA AND/OR CONTENT FROM THE COMPANIES' RESPECTIVE SERVERS OR, IN THE CASE OF GRACENOTE, CHANGE DATA CATEGORIES FOR ANY CAUSE THAT GRACENOTE DEEMS SUFFICIENT. NO WARRANTY IS MADE THAT EITHER GRACENOTE CONTENT OR THE GRACENOTE SOFTWARE OR GRACENOTE SERVERS ARE ERROR-FREE OR THAT THE FUNCTIONING OF THE GRACENOTE SOFTWARE OR GRACENOTE SERVERS WILL BE UNINTERRUPTED. GRACENOTE IS NOT OBLIGATED TO PROVIDE YOU WITH ANY ENHANCED OR ADDITIONAL DATA TYPES THAT GRACENOTE MAY CHOOSE TO PROVIDE IN THE FUTURE AND IS FREE TO DISCONTINUE ITS ONLINE SERVICES AT ANY TIME. GRACENOTE DISCLAIM ALL WARRANTIES EXPRESS OR IMPLIED, INCLUDING, BUT NOT LIMITED TO, IMPLIED WARRANTIES OF MERCHANTABILITY, FITNESS FOR A PARTICULAR PURPOSE, TITLE, AND NON-INFRINGEMENT. NEITHER GRACENOTE WARRANTS THE RESULTS THAT WILL BE OBTAINED BY YOUR USE OF THE GRACENOTE SOFTWARE OR ANY GRACENOTE SERVER. IN NO CASE WILL GRACENOTE BE LIABLE FOR ANY CONSEQUENTIAL OR INCIDENTAL DAMAGES OR FOR ANY LOST PROFITS OR LOST REVENUES FOR ANY REASON WHATSOEVER.

© Gracenote 2007.

FCC ID: KMHSYNGC2

IC: 1422A-SYNGC2

This device complies with Part 15 of the FCC Rules and with RSS-210 of Industry Canada. Operation is subject to the following two conditions: (1) This device may not cause harmful interference, and (2) this device must accept any interference received, including interference that may cause undesired operation.

## WARNING



Changes or modifications not expressly approved by the party responsible for compliance could void the user's authority to operate the equipment. The term "IC" before the radio certification number only signifies that Industry Canada technical specifications were met.

The antenna used for this transmitter must not be co-located or operating in conjunction with any other antenna or transmitter.



# Index

## A

A/C

See: Climate Control.....68

About This Manual.....5

Protecting the Environment.....5

ABS

See: Brakes.....101

ABS driving hints

See: Hints on Driving With Anti-Lock

Brakes.....101

Accessories

See: Replacement Parts

Recommendation.....7

Active City Stop.....111

General Information.....111

Laser Sensor Information.....112

Using Active City Stop.....111

Adjusting the Steering Wheel.....38

Air Conditioning

See: Climate Control.....68

Air Vents.....68

Centre Air Vents.....68

Side Air Vent.....68

Alarm

See: Anti-Theft Alarm.....35

Anti-Theft Alarm.....35

Alarm System.....35

Arming the Alarm.....36

Disarming the Alarm.....37

Full and Reduced Guard.....36

Triggering the Alarm.....36

Appendices.....225

At a Glance.....8

Front Exterior Overview.....8

Instrument Panel Overview.....10

Rear Exterior Overview.....13

Vehicle Interior Overview.....9

Audible Warnings and Indicators.....56

Automatic Transmission.....56

Headlamps On.....56

Key Outside Car.....56

Low Fuel.....57

Seat Belt Minder.....57

Audio Control.....38

.....38

Audio System.....171

General Information.....171

Audio System Security.....187

Audio Troubleshooting.....195

Audio unit - Vehicles With:

AM/FM/CD/Bluetooth.....177

Alternative Frequencies.....181

Automatic Volume Control.....180

Autostore Control.....180

News Broadcasts.....181

Regional Mode.....181

Sound Button.....179

Station Preset Buttons.....179

Station Tuning Control.....179

Traffic Information Control.....180

Waveband Button.....179

Audio unit - Vehicles With:

AM/FM/CD.....172

Alternative Frequencies.....176

Automatic Volume Control.....175

Autostore Control.....175

News Broadcasts.....176

Regional Mode.....176

Sound Button.....174

Station Preset Buttons.....174

Station Tuning Control.....174

Traffic Information Control.....175

Waveband Button.....174

Audio unit - Vehicles With: Sony

AM/FM/CD.....182

Alternative Frequencies.....186

Automatic Volume Control.....186

Autostore Control.....185

Digital Signal Processing.....186

News Broadcasts.....186

Regional Mode.....187

Sound Button.....184

Station Preset Buttons.....184

Station Tuning Control.....184

Traffic Information Control.....185

Waveband Button.....184

Autolamps.....43

Automatic Climate Control.....70

Temperature Control.....72

# Index

Automatic Transmission.....	97	Changing a Road Wheel.....	160
Emergency Park Position Release		Assembling the Wheel Brace.....	162
Lever.....	99	Installing a Road Wheel.....	163
Hints on Driving With an Automatic		Jacking and Lifting Points.....	161
Transmission.....	98	Removing a Road Wheel.....	163
Selector Lever Positions.....	97	Removing the Wheel Trim.....	162
Sport Mode and Manual Shifting.....	98	Vehicle Jack.....	160
Autowipers.....	40	Vehicles With a Spare Wheel.....	160
Auxiliary Input Socket.....	194	Wheel Nuts.....	160
Auxiliary Power Points.....	81	Changing the 12V Battery.....	141
Location.....	81	Changing the Wiper Blades.....	141
<b>B</b>		Rear Window Wiper Blade.....	142
Bonnet Lock		Windscreen Wiper Blades.....	141
See: Opening and Closing the Bonnet.....	134	Checking the Wiper Blades.....	141
Brake and Clutch Fluid Check.....	141	Childminder Mirror.....	50
Brakes.....	101	Child Safety.....	14
General Information.....	101	Child Safety Locks.....	19
Bulb Specification Chart.....	149	Left-Hand Side.....	19
		Right-Hand Side.....	19
		Child Seat Positioning.....	16
		Cigar Lighter.....	81
		Cleaning the Alloy Wheels.....	154
		Cleaning the Exterior.....	153
		Body Paintwork Preservation.....	153
		Cleaning the Chrome Trim.....	153
		Cleaning the Headlamps.....	153
		Cleaning the Rear Window.....	153
		Cleaning the Interior.....	153
		Instrument Cluster Screens, LCD Screens	
		and Radio Screens.....	154
		Rear Windows.....	154
		Seat Belts.....	153
		Climate Control.....	68
		Principle of Operation.....	68
		Clock.....	61
		Type 1.....	61
		Type 2.....	61
		Cold Weather Precautions.....	121
Capacities and Specifications.....	167		
Technical Specifications.....	168		
Cargo Nets.....	114		
Installing and Removing the Net.....	114		
Car Wash			
See: Cleaning the Exterior.....	153		
Catalytic Converter.....	93		
Driving with a Catalytic Converter.....	93		
Changing a Bulb.....	143		
Approach Lamp.....	145		
Central High Mounted Brake Lamp.....	147		
Front Fog Lamps.....	145		
Headlamp.....	143		
Interior Lamp.....	148		
Licence Plate Lamp.....	148		
Luggage Compartment Lamp, Footwell			
Lamp and Liftgate Lamp.....	149		
Reading Lamps.....	148		
Rear Lamps.....	146		
Side Lamp.....	144		
Side Repeater.....	144		
Changing a Fuse.....	133		

# Index

Compact Disc Player - Vehicles With:	
AM/FM/CD/Bluetooth/Sony	
AM/FM/CD.....	190
CD Text Display Options.....	193
Compact Disc Playback.....	190
Compact Disc Track Scanning.....	191
Ending Compact Disc Playback.....	193
Fast Forward and Reverse.....	191
MP3 and WMA Display Options.....	193
MP3 and WMA File Playback.....	191
Repeat Compact Disc Tracks.....	191
Shuffle and Random.....	191
Track Selection.....	191
Compact Disc Player - Vehicles With:	
AM/FM/CD.....	187
CD Text Display Options.....	190
Compact Disc Playback.....	187
Compact Disc Track Scanning.....	188
Ending Compact Disc Playback.....	190
Fast Forward and Reverse.....	187
MP3 and WMA Display Options.....	190
MP3 and WMA File Playback.....	188
Repeat Compact Disc Tracks.....	188
Shuffle and Random.....	187
Track Selection.....	187
Coolant Check	
See: Engine Coolant Check.....	140
Cruise Control.....	39
Principle of Operation.....	109
Cruise control	
See: Using Cruise Control.....	109
Cup Holders.....	82
<b>D</b>	
Daytime Running Lamps.....	45
Diesel Particulate Filter.....	87
Regeneration.....	87
Direction Indicators.....	47
Dog Guard.....	114
DPF	
See: Diesel Particulate Filter.....	87
Driver Airbag.....	22
.....	22
Driving Aids.....	111
Driving Hints.....	121
Driving Through Water.....	121
.....	121
DRL	
See: Daytime Running Lamps.....	45
<b>E</b>	
Electromagnetic compatibility.....	225
End User Licence Agreement.....	226
SYNC® End User Licence Agreement	
(EULA).....	226
Engine Coolant Check.....	140
Adding Engine Coolant.....	140
Engine Immobiliser	
See: Passive Anti-Theft System.....	35
Engine Oil Check.....	139
Checking the Oil Level.....	139
Topping Up.....	140
Engine Oil Dipstick - 1.0L EcoBoost	
(74kW/100PS)/1.0L EcoBoost	
(90kW/120PS).....	139
Engine Oil Dipstick - 1.4L Duratec-16V	
(66kW/90PS)/1.6L Duratec-16V	
Ti-VCT (77kW/105PS) - Sigma.....	139
Engine Oil Dipstick - 1.5L Duratorq-TDCi	
(55kW/75PS)/1.6L Duratorq-TDCi	
(70kW/95PS) (T3).....	139
.....	139
Exterior Mirrors.....	49
Electric Folding Mirrors.....	49
Fold-Away Exterior Mirrors.....	50
Power Exterior Mirrors.....	49
<b>F</b>	
Fastening the Seat Belts.....	20
Using Seat Belts During Pregnancy.....	20
First Aid Kit.....	122
Flat Tyre Inflation	
See: Temporary Mobility Kit.....	155
Floor Mats.....	121
Fog Lamps - Front	
See: Front Fog Lamps.....	45
Fog Lamps - Rear	
See: Rear Fog Lamps.....	45
Front Fog Lamps.....	45
Front Seat Armrest.....	80
Fuel and Refuelling.....	91
Technical Specifications.....	96

# Index

Fuel Consumption.....	95	Heated Windows and Mirrors.....	75
Calculating Fuel Economy.....	95	Heated Exterior Mirrors.....	75
Filling the Tank.....	95	Heated Windows.....	75
Fuel Consumption		Heating	
See: Technical Specifications.....	96	See: Climate Control.....	68
Fuel Quality - Diesel.....	92	Hill Start Assist.....	99
Long-Term Storage.....	92	Switching the System On and Off.....	100
Fuel Quality - Petrol.....	92	Using Hill Start Assist.....	100
Long-Term Storage.....	92	Hints on Controlling the Interior	
Fuse Box Locations.....	124	Climate.....	72
Engine Compartment Fuse Box.....	124	Cooling the Interior Quickly.....	73
Passenger's Compartment Fuse Box.....	124	General Hints.....	72
Fuses.....	124	Heating the Interior Quickly.....	73
Fuse Specification Chart.....	125	Maximum Cooling Performance in	
Engine Compartment Fuse Box.....	125	Instrument Panel or Instrument Panel	
Passenger's Compartment Fuse Box - Type		and Footwell Positions.....	75
1.....	128	Recommended Settings for Cooling .....	74
Passenger's Compartment Fuse Box - Type		Recommended Settings for Heating.....	73
2.....	130	Side Window Defogging in Cold	
		Weather.....	74
		Vehicle Stationary for Extended Periods	
		During Extreme High Ambient	
		Temperatures.....	74
		Hints on Driving With Anti-Lock	
		Brakes.....	101
<b>G</b>		<b>I</b>	
Gauges.....	53	Ignition Switch.....	83
Fuel Gauge.....	53	Information Displays.....	58
Gearbox		General Information.....	58
See: Transmission.....	97	Information Messages.....	62
General Information on Radio		Installing Child Seats.....	14
Frequencies.....	25	Attaching a Child Seat With Top	
Glasses Holder.....	82	Tethers.....	16
Global Opening and Closing.....	51	Booster Seats.....	15
Global Closing.....	51	Child Seats for Different Mass Groups.....	14
Global Opening.....	51	ISOFIX Anchor Points.....	16
		Top Tether Anchor Points.....	16
		Instrument Cluster.....	53
<b>H</b>		Instrument Lighting Dimmer.....	44
Handbrake		.....	44
See: Parking Brake.....	101	Interior Lamps.....	47
Hazard Warning Flashers.....	122	Courtesy Lamp.....	47
Headlamp Exit Delay.....	44	Reading Lamps.....	47
Headlamp Levelling.....	46	Interior Mirror.....	50
Recommended Headlamp Levelling Switch		Auto-Dimming Mirror.....	50
Positions.....	46	Introduction.....	5
Head Restraints.....	76		
.....	76		
Adjusting the Head Restraints.....	76		
Removing the Head Restraint.....	77		
Heated Seats.....	80		



# Index

## J

Jump-Starting the Vehicle.....	122
To Connect the Booster Cables.....	122
To Start the Engine.....	123

## K

Keyless Entry.....	32
Disabled Keys.....	33
General Information.....	32
Locking and Unlocking the Doors With the Key Blade.....	34
Locking Your Vehicle.....	32
Passive Key.....	32
Unlocking Your Vehicle.....	33
Keyless Starting.....	83
Failure to Start.....	84
Ignition On.....	84
Starting a Diesel Engine.....	84
Starting With Automatic Transmission.....	84
Starting With Manual Transmission.....	84
Stopping the Engine When Your Vehicle is Moving.....	85
Stopping the Engine With Your Vehicle Stationary.....	85
Keys and Remote Controls.....	25
Knee Airbag.....	24

## L

Lighting Control.....	43
Headlamp Flasher.....	43
Lighting Control Positions.....	43
Main Beams.....	43
Parking Lamps.....	43
Lighting.....	43
Load Carrying.....	113
General Information.....	113
Locking and Unlocking.....	29
Locking and Unlocking the Doors From Inside.....	29
Locking and Unlocking the Doors With the Key.....	29
Power Door Locks.....	29
Remote Control.....	29
Locks.....	29

Luggage Anchor Points.....	113
Luggage Covers.....	114

## M

Maintenance.....	134
General Information.....	134
Technical Specifications.....	150
Manual Climate Control.....	69
Manual Liftgate.....	31
Opening and Closing the Liftgate.....	31
Manual Seats.....	78
Adjusting the Height of the Driver's Seat.....	78
Adjusting the Lumbar Support.....	78
Folding the Passenger's Seat Forward.....	79
Moving the Seat Backward and Forward.....	78
Recline Adjustment.....	79
Manual Transmission.....	97
Selecting Reverse Gear.....	97
Message Centre	
See: Information Displays.....	58
Mirrors	
See: Heated Windows and Mirrors.....	75
See: Windows and Mirrors.....	48
Mobile Communications Equipment.....	7

## O

Oil Check	
See: Engine Oil Check.....	139
Opening and Closing the Bonnet.....	134
Closing the Bonnet.....	135
Opening the Bonnet.....	134

## P

Parking Aid.....	104
Front and Rear Sensing System.....	105
Rear Sensing System.....	105
Parking Aids.....	104
Principle of Operation.....	104
Parking Brake.....	101
All Vehicles.....	102
Vehicles With Automatic Transmission.....	101
Vehicles With Manual Transmission.....	101

# Index

Passenger Airbag.....	22	Remote Control.....	25
.....	22	Changing the Remote Control Battery.....	26
Switching the Passenger's Airbag Off.....	23	Programming a New Remote Control.....	25
Switching the Passenger's Airbag On.....	23	Remote Control With a Folding Key	
Passive Anti-Theft System.....	35	Blade.....	26
Arming the Engine Immobiliser.....	35	Remote Control Without a Folding Key	
Coded Keys.....	35	Blade.....	27
Disarming the Engine Immobiliser.....	35	Reprogramming the Unlocking	
Principle of Operation.....	35	Function.....	25
PATS		Removing a Headlamp.....	142
See: Passive Anti-Theft System.....	35	Repairing Minor Paint Damage.....	154
Personalised Settings.....	62	Replacement Parts	
Measure Units.....	62	Recommendation.....	7
Switching Chimes Off.....	62	Collision Repairs.....	7
Power Door Locks		Scheduled Maintenance and Mechanical	
See: Locking and Unlocking.....	29	Repairs.....	7
Power Windows.....	48	Warranty on Replacement Parts.....	7
Accessory Delay.....	49	Replacing a Lost Key or Remote	
Bounce-Back.....	48	Control.....	28
One-Touch Down.....	48	Roadside Emergencies.....	122
One-Touch Up.....	48	Running-In.....	121
Window Lock.....	48	Brakes and Clutch.....	121
		Engine.....	121
<b>R</b>		Tyres.....	121
Rear Fog Lamps.....	45	Running Out of Fuel.....	92
Rear Seats.....	79	Refilling With a Portable Fuel	
Folding the Seatback.....	79	Container.....	93
Unfolding the Seatback.....	80	<b>S</b>	
Rear Under Floor Storage.....	113	Safety Precautions.....	91
Adjustable Load Floor.....	113	Seat Belt Minder.....	21
Rear View Camera.....	106	Turning the Seat Belt Minder Off.....	21
Switching the Rear View Camera Off.....	108	Seat Belts.....	20
Switching the Rear View Camera On.....	107	Seats.....	76
Using the Display.....	107	Security.....	35
Vehicles with Parking Aid.....	108	Side Airbags.....	23
Rear View Camera		Side Curtain Airbags.....	24
See: Rear View Camera.....	106	.....	24
Rear Window Wiper and Washers.....	41	Sitting in the Correct Position.....	76
Intermittent Wipe.....	41	Sliding Door.....	30
Rear Window Washer.....	42	Snow Chains	
Reverse Gear Wipe.....	42	See: Using Snow Chains.....	159
Refuelling.....	93	Speed Control	
		See: Cruise Control.....	109
		Stability Control.....	103
		Principle of Operation.....	103

# Index

Starter Switch	
See: Ignition Switch.....	83
Starting a Diesel Engine.....	86
Cold or Hot Engine.....	86
Failure to Start.....	87
Starting and Stopping the Engine.....	83
General Information.....	83
Starting a Petrol Engine.....	85
Cold or Hot Engine.....	85
Engine Idle Speed after Starting.....	86
Failure to Start.....	86
Flooded Engine.....	86
Start-Stop.....	89
To Re-Start the Engine.....	90
To Stop the Engine.....	89
Using Start-Stop.....	89
Steering Wheel Lock.....	85
Vehicles With Keyless Starting.....	85
Vehicles Without Keyless Starting.....	85
Steering Wheel.....	38
Storage Compartments.....	82
Supplementary Restraints System.....	22
Principle of Operation.....	22
Switching Off the Engine.....	88
Vehicles With a Turbocharger.....	88
Symbols Glossary.....	5
SYNC® Applications and Services.....	211
In the Event of a Collision.....	212
Setting Emergency Assistance On.....	211
SYNC Emergency Assistance.....	211
SYNC® Troubleshooting.....	218
SYNC.....	196
General Information.....	196
<b>T</b>	
Technical Specifications	
See: Capacities and Specifications.....	167
Temporary Mobility Kit.....	155
General Information.....	155
Inflating the Tyre.....	156
Using the Kit.....	155
Tow Ball.....	116
Driving With a Trailer.....	117
Driving Without a Trailer.....	118
Inserting the Tow Ball Arm.....	117
Maintenance.....	119
Removing the Tow Ball Arm.....	118
Unlocking the Tow Ball Arm	
Mechanism.....	117
Towing a Trailer.....	116
Steep Gradients.....	116
Towing Points.....	119
Towing the Vehicle on Four	
Wheels.....	119
All Vehicles.....	119
Vehicles With Automatic	
Transmission.....	120
Towing.....	116
Transmission.....	97
Trip Computer.....	61
.....	61
Distance Odometer.....	62
Tyre Care.....	158
Tyre Inflation When Punctured	
See: Temporary Mobility Kit.....	155
Tyre Pressure Monitoring System.....	159
System Reset.....	160
Tyre Pressures	
See: Technical Specifications.....	164
Tyre Repair Kit	
See: Temporary Mobility Kit.....	155
Tyres	
See: Wheels and Tyres.....	155
<b>U</b>	
Under Bonnet Overview - 1.0L EcoBoost	
(74kW/100PS)/1.0L EcoBoost	
(90kW/120PS).....	136
Under Bonnet Overview - 1.4L	
Duratec-16V (66kW/90PS)/1.6L	
Duratec-16V Ti-VCT (77kW/105PS) -	
Sigma.....	137
Under Bonnet Overview - 1.5L	
Duratorq-TDCi (55kW/75PS)/1.6L	
Duratorq-TDCi (70kW/95PS)	
(T3).....	138
Unique Driving Characteristics.....	89

# Index

Using Cruise Control.....	109
Cancelling the Set Speed.....	110
Changing the Set Speed.....	109
Resuming the Set Speed.....	110
Setting a Speed.....	109
Switching Cruise Control Off.....	110
Switching Cruise Control On.....	109
Using Snow Chains.....	159
Vehicles With Stability Control.....	159
Using Stability Control.....	103
Using SYNC® With Your Media Player.....	213
Accessing Your USB Song Library.....	217
Bluetooth Devices and System Settings.....	218
Connecting Your Digital Media Player to the USB Port.....	214
Media Menu Features.....	216
Media Voice Commands.....	214
What's Playing?.....	214
Using SYNC® With Your Phone.....	200
Accessing Features through the Mobile Phone Menu.....	204
Accessing Your Mobile Phone Settings.....	207
BT Devices.....	208
Making Calls.....	203
Mobile Phone Options During an Active Call.....	203
Mobile Phone Voice Commands.....	201
Pairing a Mobile Phone For the First Time.....	200
Pairing Subsequent Mobile Phones.....	201
Receiving Calls.....	203
Text Messaging.....	206
Using Voice Recognition.....	198
Helpful Hints.....	198
Initiating a Voice Session.....	198
System Interaction and Feedback.....	198
Using Winter Tyres.....	159
<b>V</b>	
Vehicle Care.....	153
Vehicle Identification Number.....	168
Vehicle Identification Plate.....	167
Ventilation	
See: Climate Control.....	68
Vents	
See: Air Vents.....	68
VIN	
See: Vehicle Identification Number.....	168
Voice Control.....	39
<b>W</b>	
Warning Lamps and Indicators.....	53
Anti-lock Braking System Warning Lamp.....	54
Brake System Warning Lamp.....	54
Coolant Temperature Warning Lamp.....	54
Cruise Control Indicator.....	54
Direction Indicator.....	54
Door Ajar Warning Lamp.....	54
Engine Warning Lamps.....	54
Front Airbag Warning Lamp.....	55
Front Fog Lamp Indicator.....	55
Frost Warning Lamp.....	55
Glow Plug Indicator.....	55
Headlamp Indicator.....	55
Ignition Warning Lamp.....	55
Low Fuel Level Warning Lamp.....	55
Low Tyre Pressure Warning Lamp.....	55
Main Beam Indicator.....	55
Message Centre Indicator.....	56
Oil Pressure Warning Lamp.....	56
Power Steering Warning Lamp.....	56
Rear Fog Lamp Indicator.....	56
Seat Belt Minder Warning Lamp.....	56
Shift Indicator.....	56
Stability Control Indicator.....	56
Warning Triangle.....	122
Washer Fluid Check.....	141
Washers	
See: Wipers and Washers.....	40
Washing	
See: Cleaning the Exterior.....	153
Wheels and Tyres.....	155
General Information.....	155
Technical Specifications.....	164
Windows and Mirrors.....	48
Windscreen Washers.....	41

# Index

---

Windscreen Wipers.....	40
Intermittent Wipe.....	40
Speed Dependent Wipers.....	40
Winter Tyres	
See: Using Winter Tyres.....	159
Wipers and Washers.....	40





